

Mathematical Foundations of Elasticity Theory

John Ball

Oxford Centre for Nonlinear PDE

©J.M.Ball

Reading

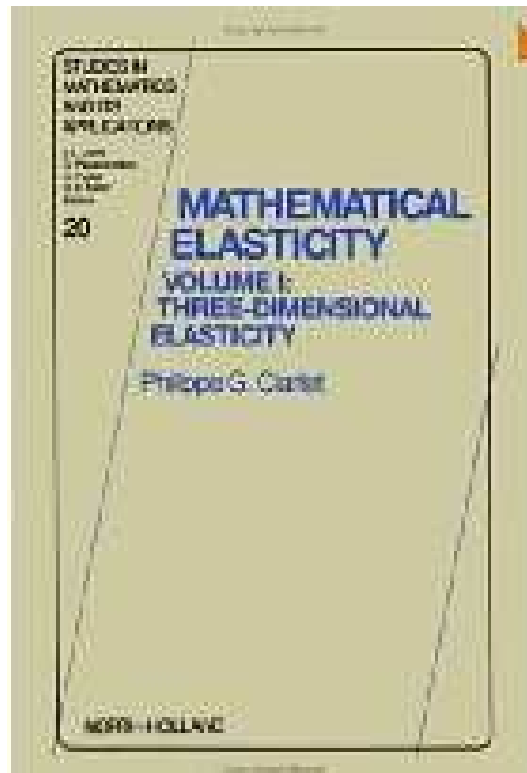

Ciarlet

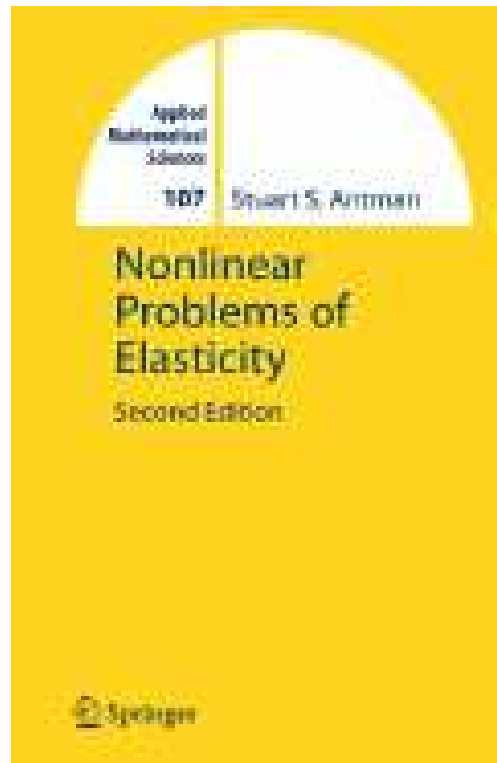

Antman

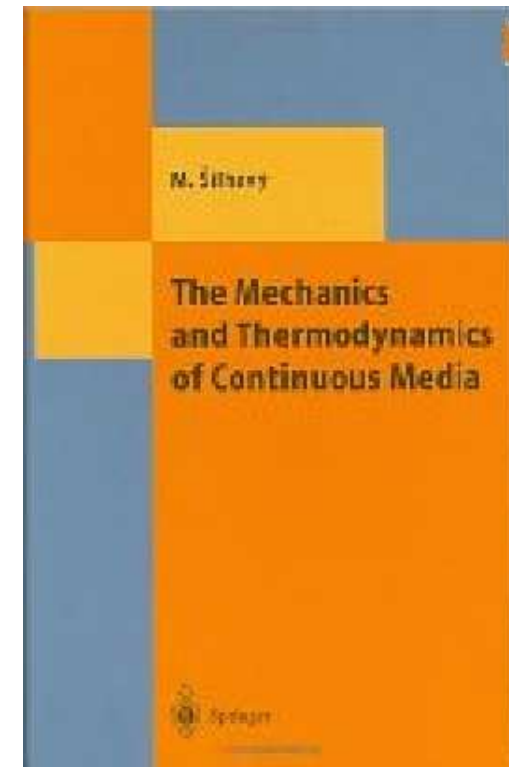

Silhavy

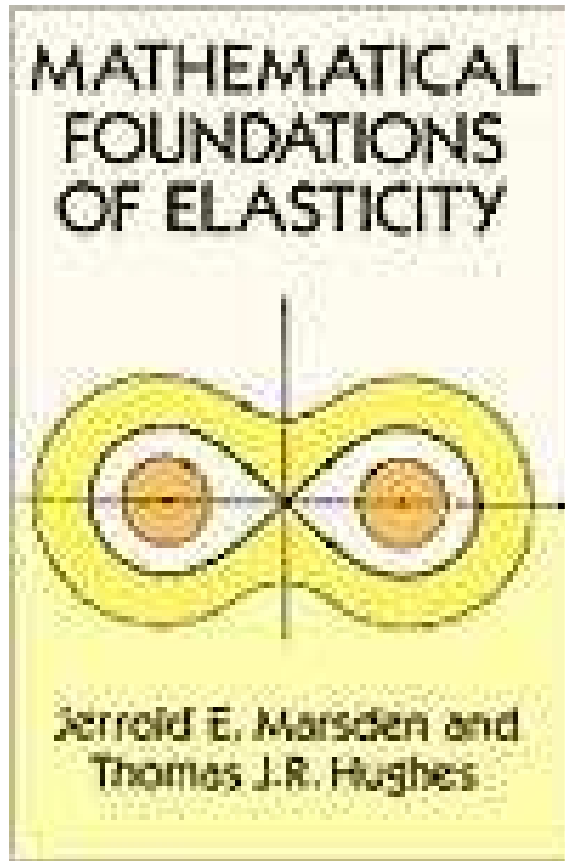

Prentice Hall 1983

Max-Planck-Institut für Mathematik
in den Naturwissenschaften

Lecture note 2/1998
**Variational models for microstructure
and phase transitions**

Stefan Müller

<http://www.mis.mpg.de/>

Clifford Truesdell
Walter Noll

The Non-Linear Field Theories of Mechanics

Edited by Stuart S. Antman

Third Edition

 Springer

J.M. Ball, *Some open problems in elasticity*. In *Geometry, Mechanics, and Dynamics*, pages 3--59, Springer, New York, 2002.

You can download this from my webpage

<http://www.maths.ox.ac.uk/~ball>

Elasticity Theory

The central model of solid mechanics. Rubber, metals (and alloys), rock, wood, bone ... can all be modelled as elastic materials, even though their chemical compositions are very different.

For example, metals and alloys are crystalline, with grains consisting of regular arrays of atoms. Polymers (such as rubber) consist of long chain molecules that are wriggling in thermal motion, often joined to each other by chemical bonds called crosslinks. Wood and bone have a cellular structure ...

A brief history

1678 Hooke's Law

1705 Jacob Bernoulli

1742 Daniel Bernoulli

1744 L. Euler *elastica* (elastic rod)

1821 Navier, special case of linear elasticity via molecular model

(Dalton's atomic theory was 1807)

1822 Cauchy, stress, *nonlinear* and linear elasticity

For a long time the nonlinear theory was ignored/forgotten.

1927 A.E.H. Love, Treatise on linear elasticity

1950's R. Rivlin, Exact solutions in *incompressible* nonlinear elasticity
(rubber)

1960 -- 80 Nonlinear theory clarified by J.L. Ericksen, C. Truesdell ...

1980 -- Mathematical developments, applications to materials,
biology ...

Kinematics

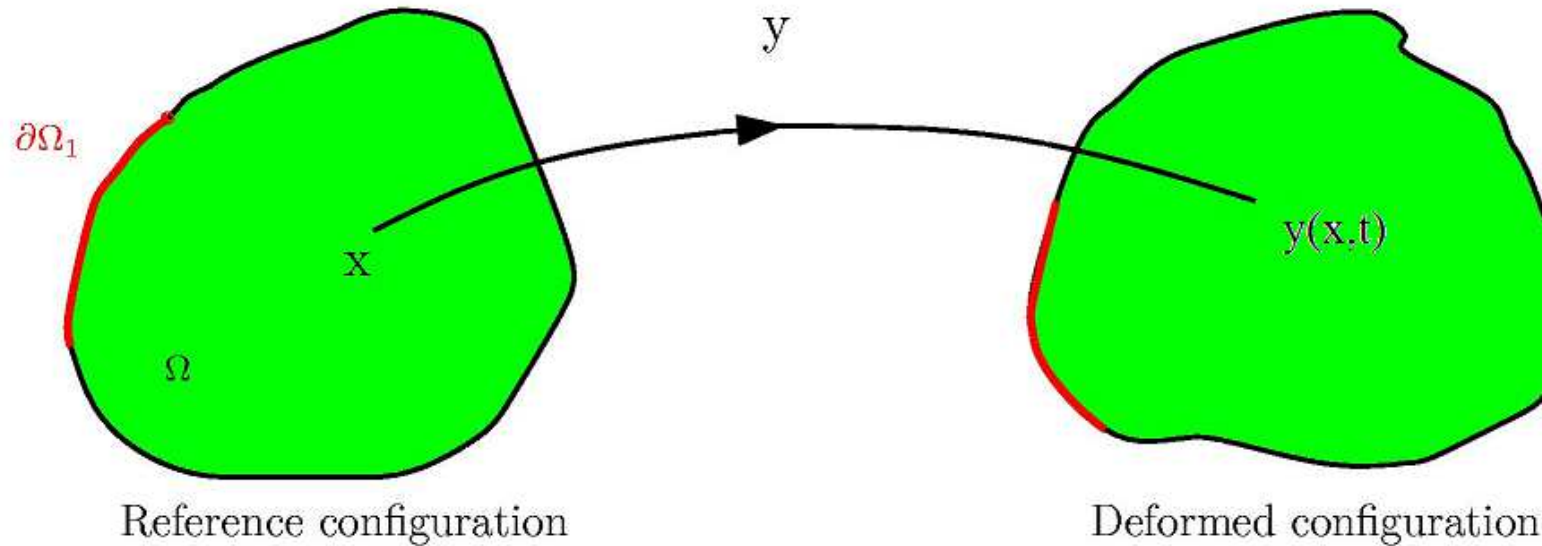

$\Omega \subset \mathbf{R}^3$ bounded domain with
(Lipschitz) boundary $\partial\Omega$.

Label the material points of the body by the positions $x \in \Omega$ they occupy in the reference configuration.

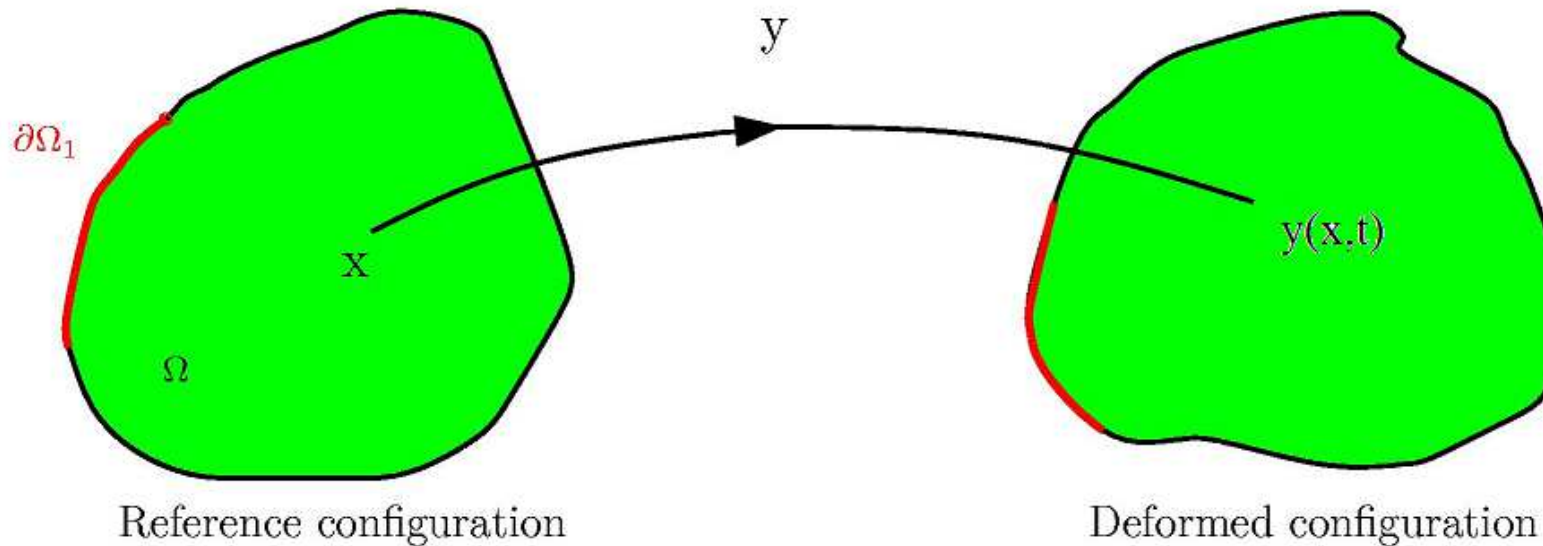

Typical motion described by a sufficiently smooth map $y : \Omega \times [t_1, t_2] \rightarrow \mathbf{R}^3$, $y = y(x, t)$.

Deformation gradient

$$F = Dy(x, t), \quad F_{i\alpha} = \frac{\partial y_i}{\partial x_\alpha}.$$

Invertibility

To avoid interpenetration of matter, we require that for each t , $y(\cdot, t)$ is invertible on Ω , with sufficiently smooth inverse $x(\cdot, t)$. We also suppose that $y(\cdot, t)$ is orientation preserving; hence

$$J = \det F(x, t) > 0 \quad \text{for } x \in \Omega. \quad (1)$$

By the inverse function theorem, if $y(\cdot, t)$ is C^1 , (1) implies that $y(\cdot, t)$ is locally invertible.

Examples.

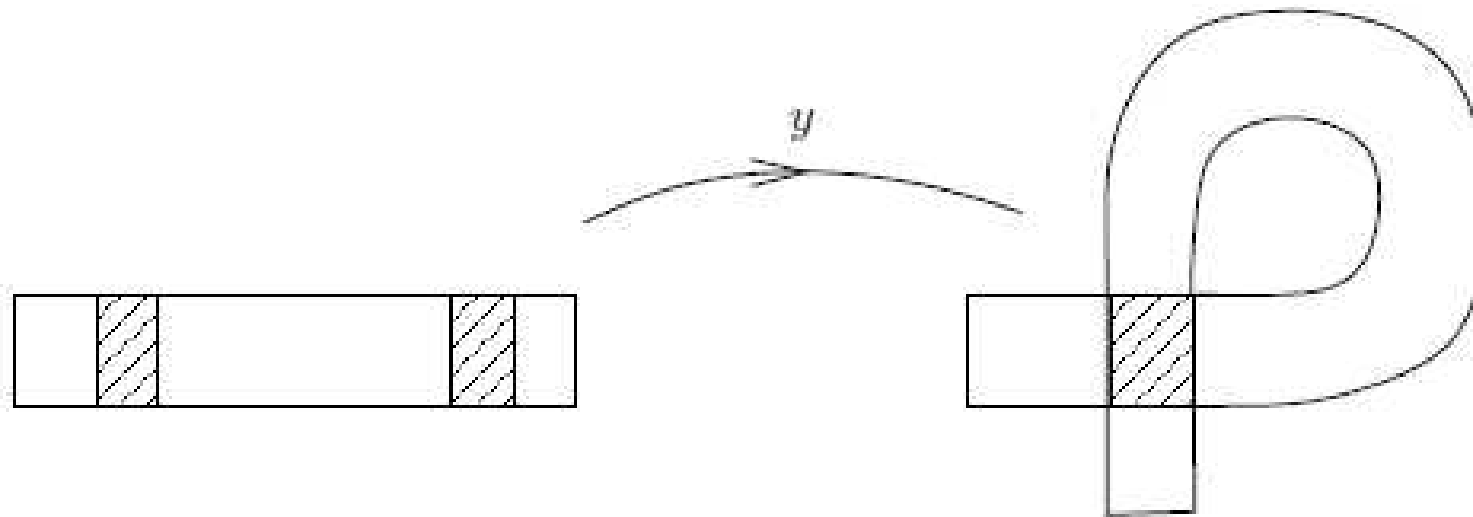

locally invertible but not globally invertible

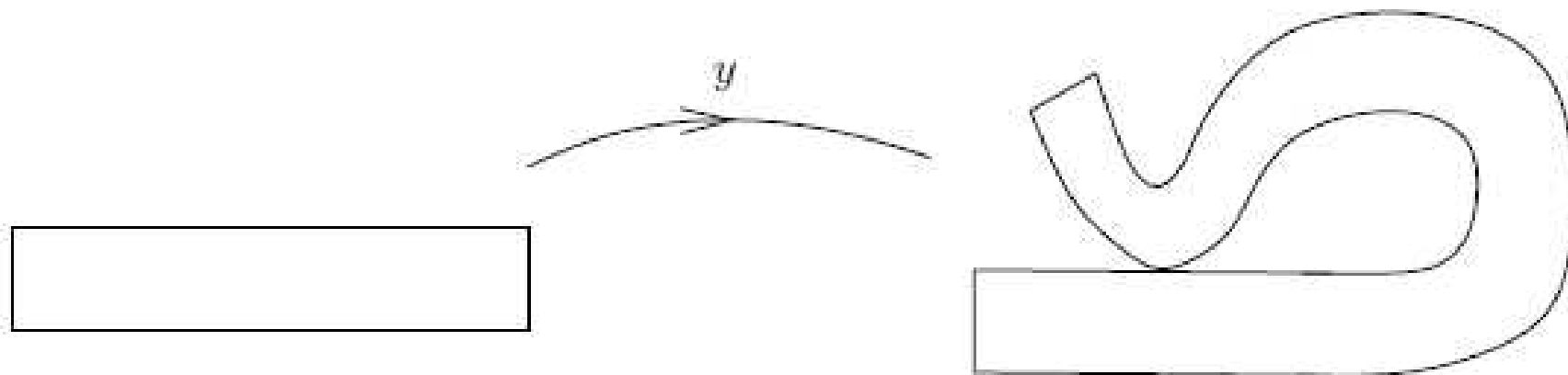

$y(\cdot, t)$ invertible on Ω
not on $\bar{\Omega}$

Global inverse function theorem for C^1 deformations

Let $\Omega \subset \mathbf{R}^n$ be a bounded domain with Lipschitz boundary $\partial\Omega$ (in particular Ω lies on one side of $\partial\Omega$ locally). Let $y \in C^1(\bar{\Omega}; \mathbf{R}^n)$ with

$$\det Dy(x) > 0 \text{ for all } x \in \bar{\Omega}$$

and $y|_{\partial\Omega}$ one-to-one. Then y is invertible on $\bar{\Omega}$.

Proof uses degree theory. cf Meisters and Olech, Duke Math. J. 30 (1963) 63-80.

Notation

$$M^{n \times n} = \{\text{real } n \times n \text{ matrices}\}$$

$$M_+^{n \times n} = \{F \in M^{n \times n} : \det F > 0\}$$

$$\begin{aligned} SO(n) &= \{R \in M^{n \times n} : R^T R = 1, \det R = 1\} \\ &= \{\text{rotations}\}. \end{aligned}$$

If $a \in \mathbf{R}^n$, $b \in \mathbf{R}^n$, the tensor product $a \otimes b$ is the matrix with the components

$$(a \otimes b)_{ij} = a_i b_j.$$

[Thus $(a \otimes b)c = (b \cdot c)a$ if $c \in \mathbf{R}^n$.]

Variational formulation of nonlinear elastostatics

We suppose for simplicity that the body is homogeneous, i.e. the material response is the same at each point. In this case the total elastic energy corresponding to the deformation $y = y(x)$ is given by

$$I(y) = \int_{\Omega} W(Dy(x)) dx,$$

where $W = W(F)$ is the *stored-energy function* of the material. We suppose that $W : M_{+}^{3 \times 3} \rightarrow \mathbf{R}$ is C^1 and bounded below, so that without loss of generality $W \geq 0$.

We will study the existence/nonexistence of minimizers of I subject to suitable boundary conditions.

Issues.

1. What function space should we seek a minimizer in? This controls the allowable singularities in deformations and *is part of the mathematical model.*
2. What boundary conditions should be specified?
3. What properties should we assume about W ?

The Sobolev space $W^{1,p}$

$W^{1,p} = \{y : \Omega \rightarrow \mathbf{R}^3 : \|y\|_{1,p} < \infty\}$, where

$$\|y\|_{1,p} = \begin{cases} (\int_{\Omega} [|y(x)|^p + |Dy(x)|^p] dx)^{1/p} & \text{if } 1 \leq p < \infty \\ \text{ess sup}_{x \in \Omega} (|y(x)| + |Dy(x)|) & \text{if } p = \infty \end{cases}$$

Dy is interpreted in the weak (or distributional) sense, so that

$$\int_{\Omega} \frac{\partial y_i}{\partial x_{\alpha}} \varphi dx = - \int_{\Omega} y_i \frac{\partial \varphi}{\partial x_{\alpha}} dx$$

for all $\varphi \in C_0^{\infty}(\Omega)$.

We assume that y belongs to the largest Sobolev space $W^{1,1} = W^{1,1}(\Omega; \mathbf{R}^3)$, so that in particular $Dy(x)$ is well defined for a.e. $x \in \Omega$, and

$$I(y) \in [0, \infty].$$

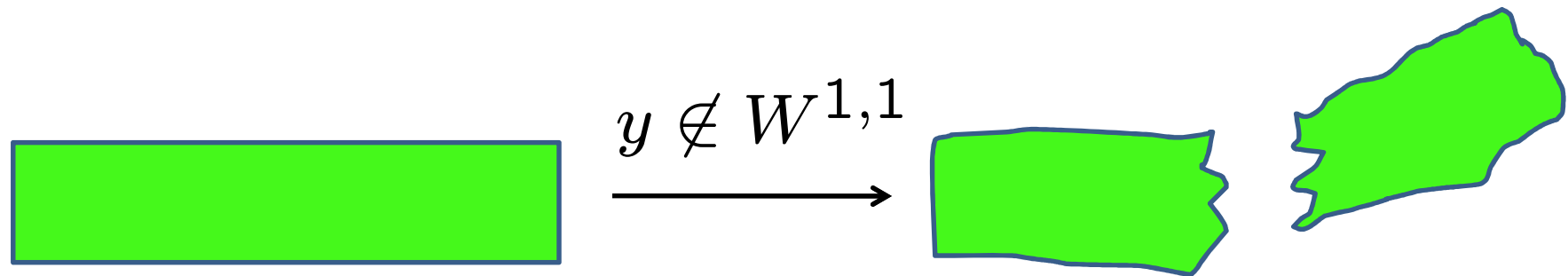
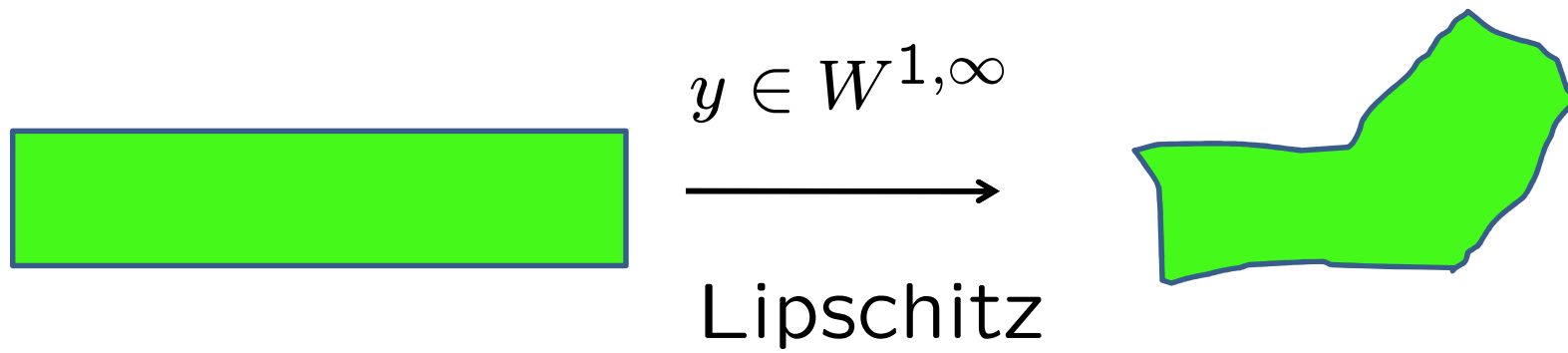

(because every $y \in W^{1,1}$ is absolutely continuous on almost every line parallel to a given direction)

Cavitation

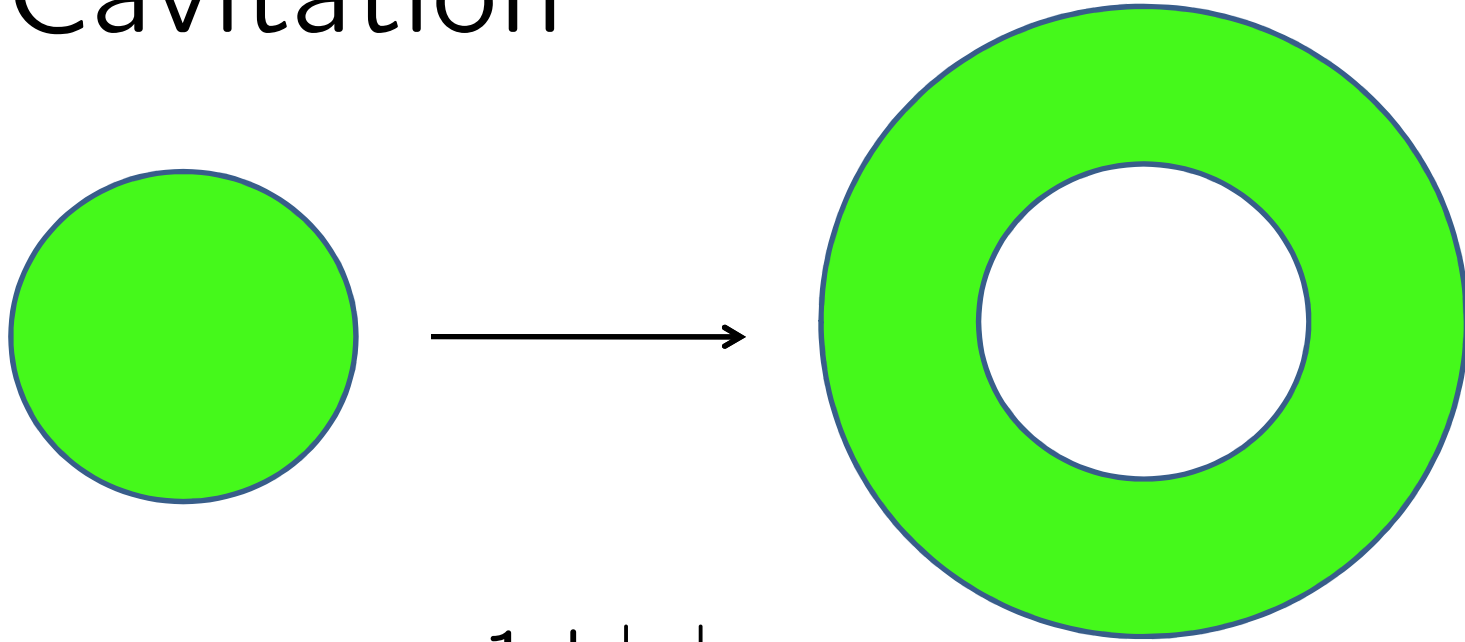

$$y(x) = \frac{1+|x|}{|x|}x$$

$y \in W^{1,p}$ for $1 \leq p < 3$.

Exercise: prove this.

Boundary conditions

We suppose that $\partial\Omega = \partial\Omega_1 \cup \partial\Omega_2 \cup N$, where $\partial\Omega_1, \partial\Omega_2$ are disjoint relatively open subsets of $\partial\Omega$ and N has two-dimensional Hausdorff measure $\mathcal{H}^2(N) = 0$ (i.e. N has zero area).

We suppose that y satisfies mixed boundary conditions of the form

$$y|_{\partial\Omega_1} = \bar{y}(\cdot),$$

where $\bar{y} : \partial\Omega_1 \rightarrow \mathbf{R}^3$ is a given boundary displacement.

By formally computing

$$\frac{d}{d\tau} I(y + \tau\varphi)|_{\tau=0} = \frac{d}{d\tau} \int_{\Omega} W(Dy + \tau D\varphi) dx|_{t=0} = 0,$$

we obtain the *weak form of the Euler-Lagrange equation* for I , that is

$$\int_{\Omega} D_F W(Dy) \cdot D\varphi dx = 0 \quad (*)$$

for all smooth φ with $\varphi|_{\partial\Omega_1} = 0$.

$$(A \cdot B = \text{tr } A^T B)$$

$T_R(F) = D_F W(F)$ is the
Piola-Kirchhoff stress tensor.

If y , $\partial\Omega_1$ and $\partial\Omega_2$ are sufficiently regular then (*) is equivalent to the pointwise form of the equilibrium equations

$$\operatorname{Div} D_F W(Dy) = 0 \quad \text{in } \Omega,$$

together with the natural boundary condition of zero applied traction

$$D_F W(Dy)N = 0 \quad \text{on } \partial\Omega_2,$$

where $N = N(x)$ denotes the unit outward normal to $\partial\Omega$ at x .

Example: boundary conditions for buckling of a bar

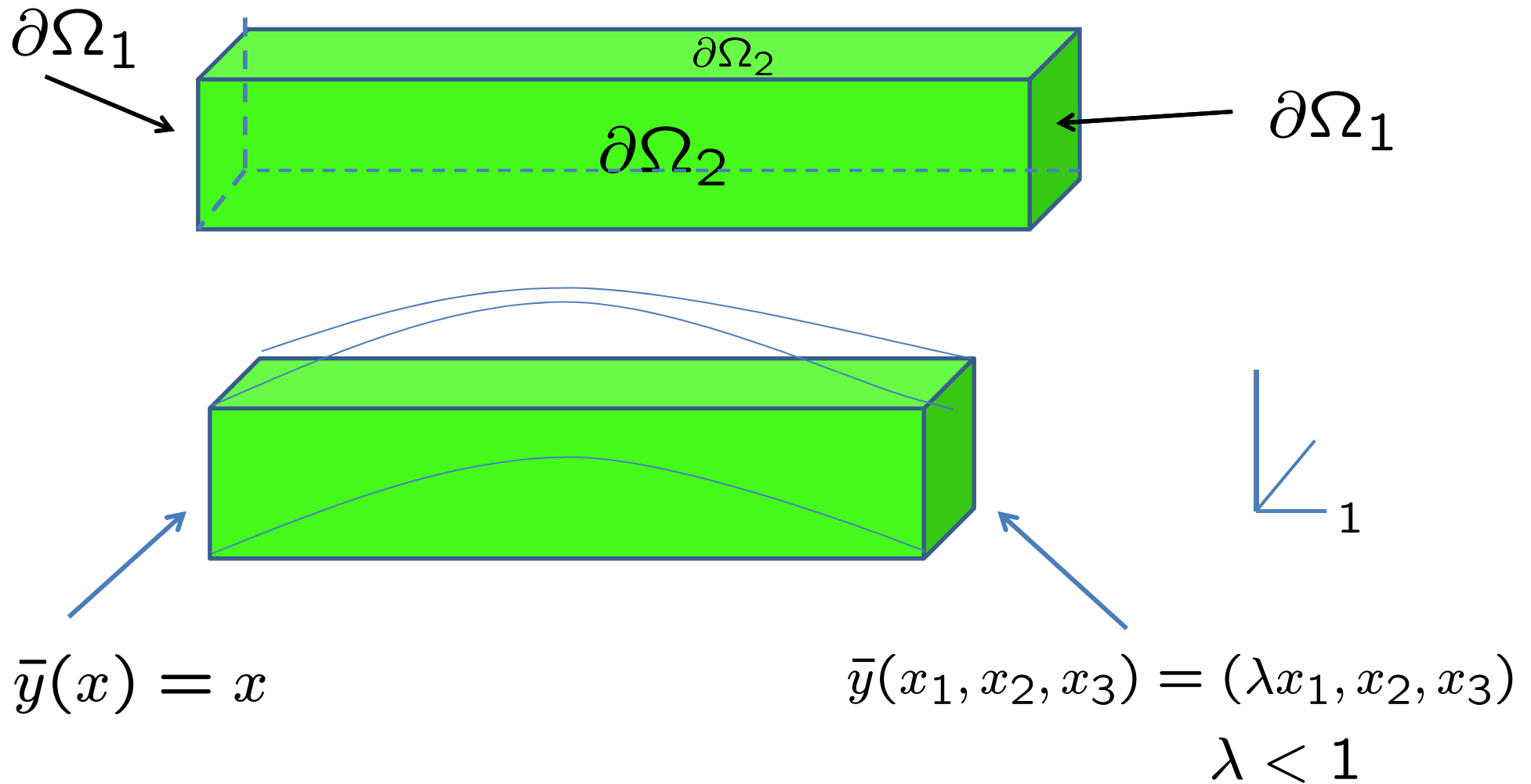

$y(\partial\Omega_2)$ traction free

Hence our variational problem becomes:

Does there exist y^* minimizing

$$I(y) = \int_{\Omega} W(Dy) dx$$

in

$$\mathcal{A} = \{y \in W^{1,1} : y \text{ invertible}, y|_{\partial\Omega_1} = \bar{y}\}?$$

We will make the invertibility condition more precise later.

Properties of W

To try to ensure that deformations are invertible, we suppose that

$$(H1) \quad W(F) \rightarrow \infty \text{ as } \det F \rightarrow 0^+.$$

So as to also prevent orientation reversal we define $W(F) = \infty$ if $\det F \leq 0$. Then $W : M^{3 \times 3} \rightarrow [0, \infty]$ is continuous.

Thus if $I(y) < \infty$ then $\det Dy(x) > 0$ a.e..
However this does not imply local invertibility (think of the map $(r, \theta) \mapsto (r, 2\theta)$ in plane polar coordinates, which has constant positive Jacobian but is not invertible near the origin), nor is it clear that $\det Dy(x) \geq \mu > 0$ a.e..

We suppose that W is *frame-indifferent*, i.e.

$$(H2) \quad W(RF) = W(F)$$

for all $R \in SO(3), F \in M^{3 \times 3}$.

In order to analyze (H2) we need some linear algebra.

Square root theorem

Let C be a positive symmetric $n \times n$ matrix. Then there is a unique positive definite symmetric $n \times n$ matrix U such that

$$C = U^2$$

(we write $U = C^{1/2}$).

Formula for the square root

Since C is symmetric it has a spectral decomposition

$$C = \sum_{i=1}^n \lambda_i \hat{e}_i \otimes \hat{e}_i.$$

Since $C > 0$, it follows that $\lambda_i > 0$. Then

$$U = \sum_{i=1}^n \lambda_i^{1/2} \hat{e}_i \otimes \hat{e}_i$$

satisfies $U^2 = C$.

Polar decomposition theorem

Let $F \in M_+^{n \times n}$. Then there exist positive definite symmetric U, V and $R \in SO(n)$ such that

$$F = RU = VR.$$

These representations (right and left respectively) are unique.

Proof. Suppose $F = RU$. Then $U^2 = F^T F := C$. Thus if the right representation exists U must be the square root of C . But if $a \in \mathbf{R}^n$ is nonzero, $Ca \cdot a = |Fa|^2 > 0$, since F is nonsingular. Hence $C > 0$. So by the square root theorem, $U = C^{1/2}$ exists and is unique. Let $R = FU^{-1}$. Then

$$R^T R = U^{-1} F^T F U^{-1} = 1$$

and $\det R = \det F (\det U)^{-1} = +1$.

The representation $F = VR_1$ is obtained similarly using $B := FF^T$, and it remains to prove $R = R_1$. But this follows from $F = R_1 \left(R_1^T V R_1 \right)$, and the uniqueness of the right representation.

Exercise: simple shear

$$y(x) = (x_1 + \gamma x_2, x_2, x_3).$$

$$\gamma = \tan \theta$$

$\theta =$ angle of shear

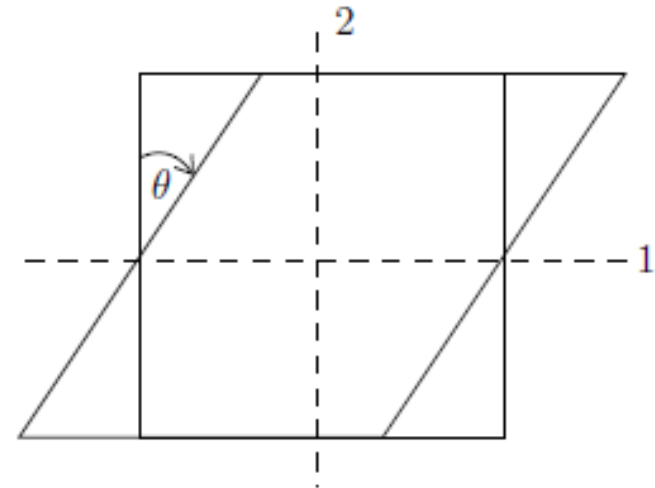

$$F = \begin{pmatrix} \cos \psi & \sin \psi & 0 \\ -\sin \psi & \cos \psi & 0 \\ 0 & 0 & 1 \end{pmatrix} \begin{pmatrix} \cos \psi & \sin \psi & 0 \\ \sin \psi & \frac{1 + \sin^2 \psi}{\cos \psi} & 0 \\ 0 & 0 & 1 \end{pmatrix},$$

$\tan \psi = \frac{\gamma}{2}$. As $\gamma \rightarrow 0+$ the eigenvectors of U and V tend to $\frac{1}{\sqrt{2}}(e_1 + e_2)$, $\frac{1}{\sqrt{2}}(e_1 - e_2)$, e_3 .

Hence (H2) implies that

$$W(F) = W(RU) = W(U) = \tilde{W}(C).$$

Conversely if $W(F) = \bar{W}(U)$ or $W(F) = \tilde{W}(C)$ then (H2) holds.

Thus frame-indifference reduces the dependence of W on the 9 elements of F to the 6 elements of U or C .

Material Symmetry

In addition, if the material has a nontrivial isotropy group \mathcal{S} , W satisfies the material symmetry condition

$$W(FQ) = W(F) \text{ for all } Q \in \mathcal{S}, F \in M_+^{3 \times 3}.$$

The case $\mathcal{S} = \text{SO}(3)$ corresponds to an *isotropic* material.

The strictly positive eigenvalues v_1, v_2, v_3 of U (or V) are called the *principal stretches*.

Proposition 1

W is isotropic iff $W(F) = \Phi(v_1, v_2, v_3)$, where Φ is symmetric with respect to permutations of the v_i .

Proof. Suppose W is isotropic. Then $F = RDQ$ for $R, Q \in SO(3)$ and $D = \text{diag}(v_1, v_2, v_3)$. Hence $W = W(D)$. But for any permutation P of 1, 2, 3 there exists \tilde{Q} such that $\tilde{Q}\text{diag}(v_1, v_2, v_3)\tilde{Q}^T = \text{diag}(v_{P1}, v_{P2}, v_{P3})$. The converse holds since $Q^T F^T F Q$ has the same eigenvalues (namely v_i^2) as $F^T F$.

(H1) and (H2) are not sufficient to prove the existence of energy minimizers. We also need growth and convexity conditions on W . The growth condition will say something about how fast W grow for large values of F . The convexity condition corresponds to a statement of the type 'stress increases with strain'. We return to the question of what the correct form of this convexity condition is later; for a summary of older thinking on this question see Truesdell & Noll.

Why minimize energy?

This is the deep problem of the *approach to equilibrium*, having its origins in the *Second Law of Thermodynamics*.

We will see how rather generally the balance of energy plus a statement of the Second Law lead to the existence of a Lyapunov function for the governing equations.

Balance of Energy

$$\begin{aligned} \frac{d}{dt} \int_E \left(\frac{1}{2} \rho_R |y_t|^2 + U \right) dx &= \int_E b \cdot y_t dx \\ &+ \int_{\partial E} t_R \cdot y_t dS + \int_E r dx - \int_{\partial E} q_R \cdot N dS, \quad (1) \end{aligned}$$

for all $E \subset \Omega$, where $\rho_R = \rho_R(x)$ is the density in the reference configuration, U is the internal energy density, b is the body force, t_R is the Piola-Kirchhoff stress vector, q_R the reference heat flux vector and r the heat supply.

Second Law of Thermodynamics

We assume this holds in the form of the *Clausius Duhem inequality*

$$\frac{d}{dt} \int_E \eta \, dx \geq - \int_{\partial E} \frac{q_R \cdot N}{\theta} \, dS + \int_E \frac{r}{\theta} \, dx \quad (2)$$

for all E , where η is the entropy and θ the temperature.

The Ballistic Free Energy

Suppose that the the mechanical boundary conditions are that $y = y(x, t)$ satisfies $y(\cdot, t)|_{\partial\Omega_1} = \bar{y}(\cdot)$ and the condition that the applied traction on $\partial\Omega_2$ is zero, and that the thermal boundary condition is

$$\theta(\cdot, t)|_{\partial\Omega_3} = \theta_0, \quad q_R \cdot N|_{\partial\Omega \setminus \partial\Omega_3} = 0,$$

where $\theta_0 > 0$ is a *constant*. Assume that the heat supply r is zero, and that the body force is given by $b = -\text{grad}_y h(x, y)$,

Thus from (1), (2) with $E = \Omega$ and the boundary conditions

$$\begin{aligned} \frac{d}{dt} \int_{\Omega} \left[\frac{1}{2} \rho_R |y_t|^2 + U - \theta_0 \eta + h \right] dx &\leq \\ \int_{\partial\Omega} t_R \cdot y_t dS - \int_{\partial\Omega} \left(1 - \frac{\theta_0}{\theta} \right) q_R \cdot N dS &= 0. \end{aligned}$$

So $\mathcal{E} = \int_{\Omega} \left[\frac{1}{2} \rho_R |y_t|^2 + U - \theta_0 \eta + h \right] dx$ is a Lyapunov function, and it is reasonable to suppose that typically (y_t, y, θ) tends as $t \rightarrow \infty$ to a (local) minimizer of \mathcal{E} .

For thermoelasticity, $W(F, \theta)$ can be identified with the Helmholtz free energy $U(F, \theta) - \theta \eta(F, \theta)$. Hence, if the dynamics and boundary conditions are such that as $t \rightarrow \infty$ we have $y_t \rightarrow 0$ and $\theta \rightarrow \theta_0$, then this is close to saying that y tends to a local minimizer of

$$I_{\theta_0}(y) = \int_{\Omega} [W(Dy, \theta_0) + h(x, y)] dx.$$

The calculation given follows work of Duhem, Ericksen and Coleman & Dill.

Of course a lot of work would be needed to justify this (we would need well-posedness of suitable dynamic equations plus information on asymptotic compactness of solutions and more; this is currently out of reach). Note that it is not the Helmholtz free energy that appears in the expression for \mathcal{E} but $U - \theta_0 \eta$, where θ_0 is the boundary temperature.

For some remarks on the case when θ_0 depends on x see J.M. Ball and G. Knowles, *Lyapunov functions for thermoelasticity with spatially varying boundary temperatures*. Arch. Rat. Mech. Anal., 92:193–204, 1986.

Existence in one dimension

To make the problem nontrivial we consider an inhomogeneous one-dimensional elastic material with reference configuration $\Omega = (0, 1)$ and stored-energy function $W(x, p)$, with corresponding total elastic energy

$$I(y) = \int_0^1 [W(x, y_x(x)) + h(x, y(x))] dx,$$

where h is the potential energy of the body force.

We seek to minimize I in the set of admissible deformations

$$\mathcal{A} = \{y \in W^{1,1}(0,1) : y_x(x) > 0 \text{ a.e.}, \\ y(0) = \alpha, y(1) = \beta\},$$

where $\alpha < \beta$. (We could also consider mixed boundary conditions $y(0) = \alpha$, $y(1)$ free.)

(Note the simple form taken by the invertibility condition.)

Hypotheses on W :

We suppose for simplicity that

$W : [0, 1] \times (0, \infty) \rightarrow [0, \infty)$ is continuous.

(H1) $W(x, p) \rightarrow \infty$ as $p \rightarrow 0+$.

As before we define $W(x, p) = \infty$ if $p \leq 0$.

(H2) is automatically satisfied in 1D.

(H3) $W(x, p) \geq \psi(p)$ for all $p > 0$,
 $x \in (0, 1)$, where $\psi : (0, \infty) \rightarrow [0, \infty)$
is continuous with $\lim_{p \rightarrow \infty} \frac{\psi(p)}{p} = \infty$.

(H4) $W(x, p)$ is convex in p , i.e.

$$W(x, \lambda p + (1 - \lambda)q) \leq \lambda W(x, p) + (1 - \lambda)W(x, q)$$

for all $p > 0, q > 0, \lambda \in (0, 1), x \in (0, 1)$.

If W is C^1 in p then (H4) is equivalent to the stress $W_p(x, p)$ being nondecreasing in the strain p .

(H5) $h : [0, 1] \times \mathbf{R} \rightarrow [0, \infty)$ is continuous.

Theorem 1

Under the hypotheses (H1)-(H5) there exists y^* that minimizes I in \mathcal{A} .

Proof.

\mathcal{A} is nonempty since $z(x) = \alpha + (\beta - \alpha)x$ belongs to \mathcal{A} . Since $W \geq 0, h \geq 0$,
 $0 \leq l = \inf_{y \in \mathcal{A}} I(y) < \infty$.

Let $y^{(j)}$ be a minimizing sequence,
i.e. $y^{(j)} \in \mathcal{A}, I(y^{(j)}) \rightarrow l$ as $j \rightarrow \infty$.

We may assume that

$$\lim_{j \rightarrow \infty} \int_0^1 W(x, y_x^{(j)}) dx = l_1,$$

$$\lim_{j \rightarrow \infty} \int_0^1 h(x, y^{(j)}) dx = l_2,$$

where $l = l_1 + l_2$.

Since $\int_{\Omega} \Psi(y_x^{(j)}) dx \leq M < \infty$, by the de la Vallée Poussin criterion (see e.g. *One-dimensional variational problems*, G. Buttazzo, M. Giaquinta, S. Hildebrandt, OUP, 1998 p 77) there exists a subsequence, which we continue to call $y_x^{(j)}$ converging weakly in $L^1(0, 1)$ to some z .

Let $y^*(x) = \alpha + \int_0^x z(s) ds$, so that $y_x^* = z$. Then $y^{(j)}(x) = \alpha + \int_0^x y_x^{(j)}(s) ds \rightarrow y^*(x)$ for all $x \in [0, 1]$. In particular $y^*(0) = \alpha$, $y^*(1) = \beta$.

By Mazur's theorem, there exists a sequence $z^{(k)} = \sum_{j=k}^{\infty} \lambda_j^{(k)} y_x^{(j)}$ of finite convex combinations of the $y_x^{(j)}$ converging *strongly* to z , and so without loss of generality almost everywhere.

By convexity

$$\begin{aligned} \int_0^1 W(x, z^{(k)}) dx &\leq \int_0^1 \sum_{j=k}^{\infty} \lambda_j^{(k)} W(x, y_x^{(j)}) dx \\ &\leq \sup_{j \geq k} \int_0^1 W(x, y_x^{(j)}) dx. \end{aligned}$$

Letting $k \rightarrow \infty$, by Fatou's lemma

$$\int_0^1 W(x, y_x^*) dx = \int_0^1 W(x, z) dx \leq l_1.$$

But this implies that $y_x^*(x) > 0$ a.e. and so $y^* \in \mathcal{A}$.

Also by Fatou's lemma

$$\int_0^1 h(x, y^*) dx \leq \liminf_{j \rightarrow \infty} \int_0^1 h(x, y^{(j)}) dx = l_2.$$

Hence $l \leq I(y^*) \leq l_1 + l_2 = l$.

So $I(y^*) = l$ and y^* is a minimizer.

Discussion of (H3)

We interpret the superlinear growth condition (H3) for a homogeneous material.

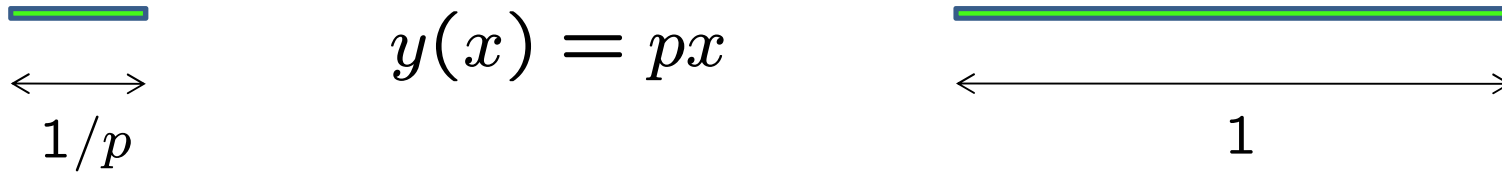
$$y(x) = px$$

$$\text{Total stored-energy} = \frac{W(p)}{p}.$$

So $\lim_{p \rightarrow \infty} \frac{W(p)}{p} = \infty$ says that you can't get a finite line segment from an infinitesimal one with finite energy.

Simplified model of atmosphere

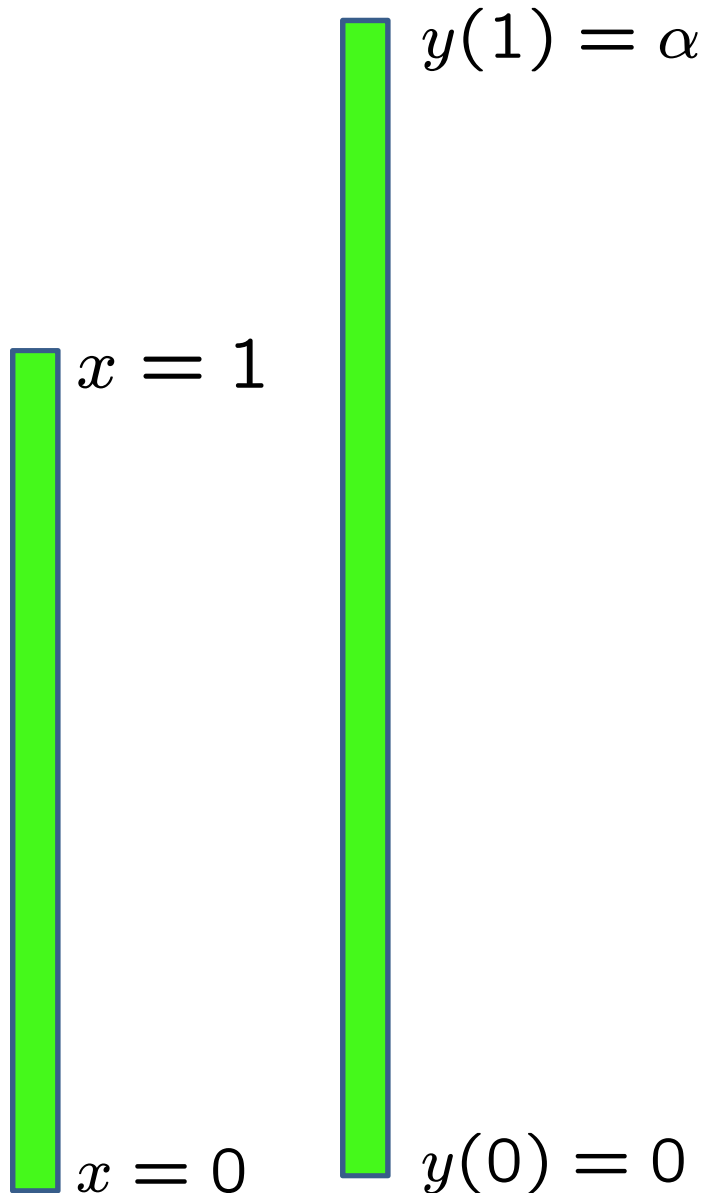

Assume constant density ρ_R and pressure p_R in the reference configuration.

Assume gas deforms adiabatically so that the pressure p and density ρ satisfy $p\rho^{-\gamma} = p_R\rho_R^{-\gamma}$, where $\gamma > 1$ is a constant.

The potential energy of the column is

$$\begin{aligned} I(y) &= \int_0^1 \left[\frac{p_R}{(\gamma - 1)y_x(x)^{\gamma-1}} + \rho_R g y(x) \right] dx \\ &= \rho_R g \int_0^1 \left[\frac{k}{y_x(x)^{\gamma-1}} + (1 - x)y_x(x) \right] dx, \end{aligned}$$

where $k = \frac{p_R}{\rho_R g(\gamma-1)}$.

We seek to minimize I in

$$\mathcal{A} = \{y \in W^{1,1}(0, 1) : y_x > 0 \text{ a.e.}, \\ y(0) = 0, y(1) = \alpha\}.$$

Then the minimum of $I(y)$ on \mathcal{A} is attained iff $\alpha \leq \alpha_{\text{crit}}$, where $\alpha_{\text{crit}} = \frac{\gamma}{\gamma-1} \left(\frac{p_R}{\rho_R g} \right)^{1/\gamma}$.

α_{crit} can be interpreted as the finite height of the atmosphere predicted by this simplified model (cf Sommerfeld).

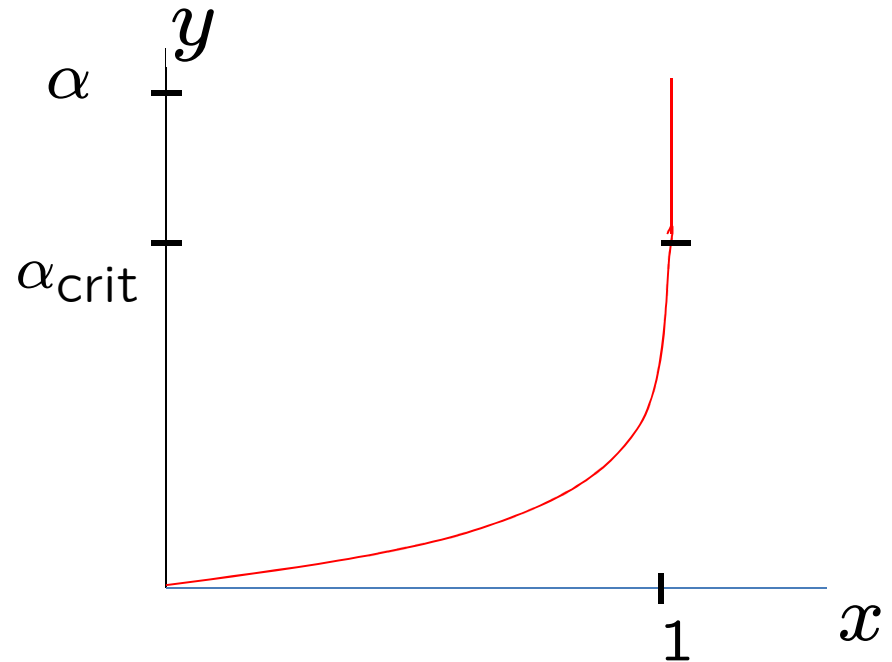

If $\alpha > \alpha_{\text{crit}}$ then minimizing sequences $y^{(j)}$ for I converge to the minimizer for $\alpha = \alpha_{\text{crit}}$ plus a vertical portion.

For details of the calculation see J.M. Ball, *Loss of the constraint in convex variational problems*, in *Analyse Mathématiques et Applications*, Gauthier-Villars, Paris, 1988, where a general framework is presented for minimizing a convex functional subject to a convex constraint, and is applied to other problems such as Thomas-Fermi and coagulation-fragmentation equations.

Discussion of (H4)

For simplicity consider the case of a homogeneous material with stored-energy function $W = W(p)$. The proof of existence of a minimizer used the direct method of the calculus of variations, the key point being that if W is convex then

$$E(p) = \int_0^1 W(p) dx$$

is weakly lower semicontinuous in $L^1(0, 1)$, i.e. $p^{(j)} \rightharpoonup p$ in $L^1(0, 1)$ (that is $\int_0^1 p^{(j)} v dx \rightarrow \int_0^1 p v dx$ for all $v \in L^\infty(0, 1)$) implies

$$\int_0^1 W(p) dx \leq \liminf_{j \rightarrow \infty} \int_0^1 W(p^{(j)}) dx.$$

Proposition 2 (Tonelli)

If E is weakly lower semicontinuous in $L^1(0, 1)$ then W is convex.

Proof. Define $p^{(j)}$ as shown.

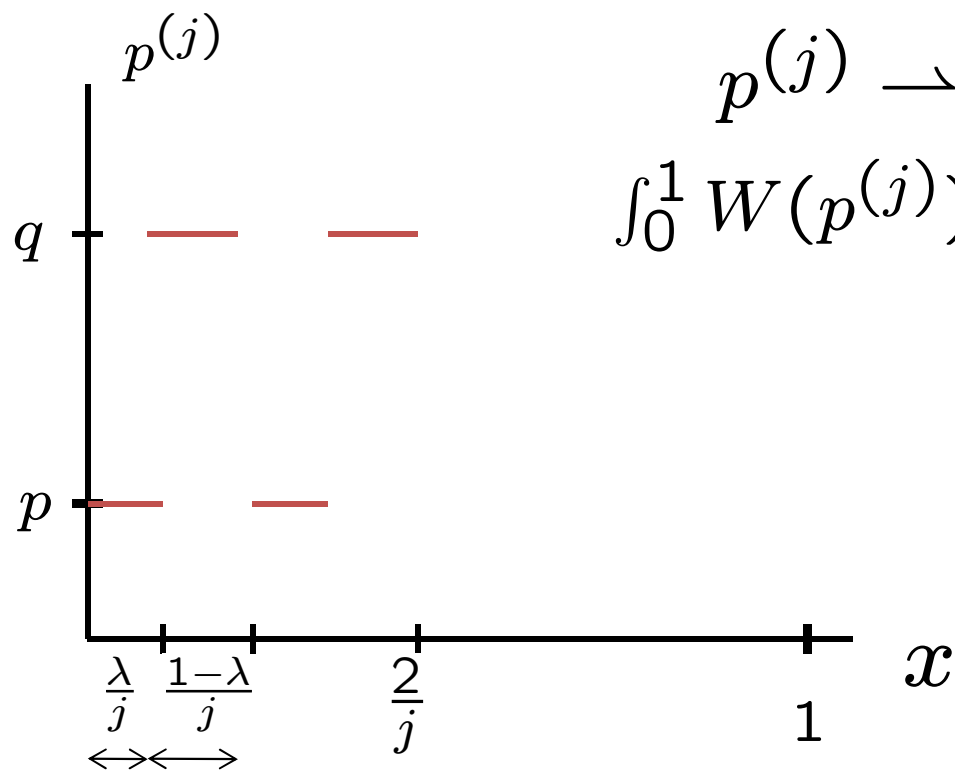

$$p^{(j)} \rightharpoonup \lambda p + (1 - \lambda)q \text{ in } L^1(0, 1)$$

$$\int_0^1 W(p^{(j)}) dx = \lambda W(p) + (1 - \lambda)W(q)$$

$$\geq W(\lambda p + (1 - \lambda)q)$$

If $W(x, \cdot)$ is not convex then the minimum is in general not attained. For example consider the problem

$$\inf_{y(0)=0, y(1)=\frac{3}{2}} \int_0^1 \left[\frac{(y_x - 1)^2 (y_x - 2)^2}{y_x} + \left(y - \frac{3}{2}x \right)^2 \right] dx.$$

Then the infimum is zero but is not attained.

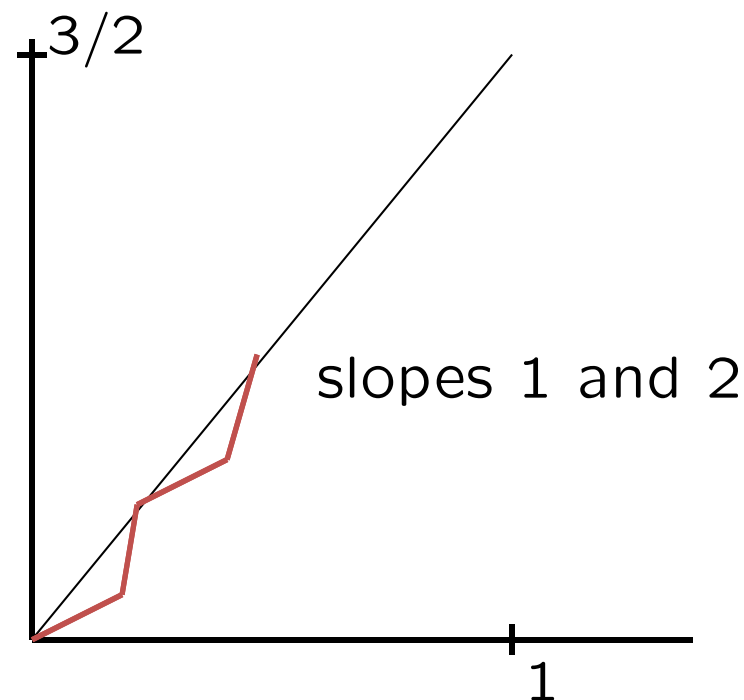

More generally we have the following result.

Theorem 2

If $W : \mathbf{R} \rightarrow [0, \infty]$ is continuous and

$$I(y) = \int_0^1 [W(y_x) + h(x, y)] dx$$

attains a minimum on

$$\mathcal{A} = \{y \in W^{1,1} : y(0) = 0, y(1) = \beta\}$$

for all continuous $h : [0, 1] \times \mathbf{R} \rightarrow [0, \infty)$ and all β then W is convex.

Let $l = \inf_{y \in \mathcal{A}} \int_0^1 W(yx) dx,$

$m = \inf_{y \in \mathcal{A}} \int_0^1 [W(yx) + |y - \beta x|^2] dx.$

Then $l \leq m.$ Let $\varepsilon > 0$ and pick $z \in \mathcal{A}$ with $\int_0^1 W(zx) dx \leq l + \varepsilon.$

Define $z^{(j)} \in \mathcal{A}$ by

$$z^{(j)}(x) = \beta \frac{k}{j} + j^{-1} z(j(x - \frac{k}{j}))$$

$$\text{for } \frac{k}{j} \leq x \leq \frac{k+1}{j}, k = 0, \dots, j-1.$$

Then

$$\begin{aligned} |z^{(j)}(x) - \beta x| &= \left| \beta \left(\frac{k}{j} - x \right) + j^{-1} z \left(j \left(x - \frac{k}{j} \right) \right) \right| \\ &\leq C j^{-1} \text{ for } \frac{k}{j} \leq x \leq \frac{k+1}{j}. \end{aligned}$$

So

$$\begin{aligned} I(z^{(j)}) &= \sum_{k=0}^{j-1} \int_{\frac{j}{k}}^{\frac{j+1}{k}} W(z_x(j(x - \frac{k}{j}))) dx + \int_0^1 |z^{(j)} - \beta x|^2 dx \\ &\leq \sum_{k=0}^{j-1} j^{-1} \int_0^1 W(z_x) dx + C j^{-2} \\ &\leq l + 2\varepsilon \end{aligned}$$

for j sufficiently large. Hence $m \leq l$ and so $l = m$.

But by assumption there exists y^* with
 $I(y^*) = \int_0^1 W(y_x^*) dx + \int_0^1 |y^* - \beta x|^2 dx = l$.

Hence $y^*(x) = \beta x$ and thus

$$\int_0^1 W(y_x) dx \geq W(\beta)$$

for all $y \in \mathcal{A}$.

Taking in particular

$$y(x) = \begin{cases} px & \text{if } 0 \leq x \leq \lambda \\ qx + \lambda(p - q) & \text{if } \lambda \leq x \leq 1, \end{cases}$$

with $\beta = \lambda p + (1 - \lambda)q$ we obtain

$$W(\lambda p + (1 - \lambda)q) \leq \lambda W(p) + (1 - \lambda)W(q)$$

as required.

There are two curious special cases when the minimum is nevertheless attained when W is not convex. Suppose that (H1), (H3) hold and that either

(i) $I(y) = \int_0^1 W(x, y_x) dx$, or

(ii) $I(y) = \int_0^1 [W(y_x) + h(y)] dx$.

Then I attains a minimum on \mathcal{A} .

(i) can be found in Aubert & Tahraoui (J. Differential Eqns 1979) and uses the fact that $\inf_{y \in \mathcal{A}} \int_0^1 W(x, y_x) dx = \inf_{y \in \mathcal{A}} \int_0^1 W^{**}(x, y_x) dx$, where W^{**} is the lower convex envelope of W .

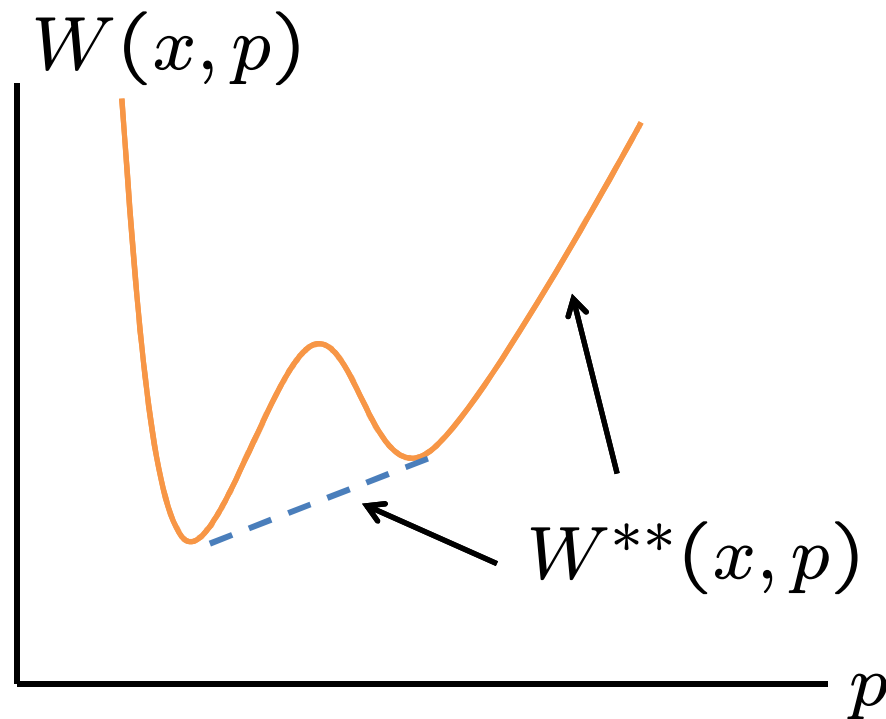

$$(ii) \quad I(y) = \int_0^1 [W(yx) + h(y)] dx$$

Exercise.

Hint: Write $x = x(y)$ and use (i).

The Euler-Lagrange equation in 1D

Let y minimize I in \mathcal{A} and let $\varphi \in C_0^\infty(0, 1)$.
Formally calculating

$$\frac{d}{d\tau} I(y + \tau\varphi)|_{\tau=0} = 0$$

we obtain the weak form of the Euler-Lagrange equation

$$\int_0^1 [W_p(x, y_x)\varphi_x + h_y(x, y)\varphi] dx = 0.$$

However, there is a serious problem in making this calculation rigorous, since we need to pass to the limit $\tau \rightarrow 0+$ in the integral

$$\int_0^1 \left[\frac{W(x, y_x + \tau \varphi_x) - W(x, y_x)}{\tau} \right] dx.$$

and the only obvious information we have is that

$$\int_0^1 W(x, y_x) dx < \infty.$$

But W_p can be much bigger than W . For example, when p is small and $W(p) = \frac{1}{p}$ then $|W_p(p)| = \frac{1}{p^2}$ is much bigger than $W(p)$. Or if p is large and $W(p) = \exp p^2$ then $|W_p(p)| = 2p \exp p^2$ is much bigger than $W(p)$.

It turns out that this is a real problem and not just a technicality. Even for smooth elliptic integrands satisfying a superlinear growth condition *there is no general theorem of the one-dimensional calculus of variations saying that a minimizer satisfies the Euler-Lagrange equation.*

Consider a general one-dimensional integral of the calculus of variations

$$I(u) = \int_0^1 f(x, u, u_x) dx,$$

where f is smooth and *elliptic* (regular), i.e.

$$f_{pp} \geq \mu > 0 \text{ for all } x, u, p.$$

Suppose also that

$$\lim_{|p| \rightarrow \infty} \frac{f(x, u, p)}{|p|} = \infty \text{ for all } x, u.$$

Suppose $u \in W^{1,1}(0, 1)$ satisfies the weak form of the Euler-Lagrange equation

$$\int_0^1 [f_p \varphi_x + f_u \varphi] dx = 0 \text{ for all } \varphi \in C_0^\infty(0, 1),$$

so that in particular $f_p, f_u \in L^1_{loc}(0, 1)$.

Then

$$f_p = \int_a^x f_u + \text{const}$$

where $a \in (0, 1)$, and hence (Exercise) u_x is bounded on compact subsets of $(0, 1)$.

It follows that u is a smooth solution of the Euler-Lagrange equation $\frac{d}{dx} f_p = f_u$ on $(0, 1)$.

Example (B & Mizel)

Minimize

$$I(u) = \int_{-1}^1 [(x^4 - u^6)^2 u_x^{28} + \epsilon u_x^2] dx$$

subject to

$$u(-1) = -1, \quad u(1) = 1,$$

with $0 < \epsilon < \epsilon_0 \approx .001$.

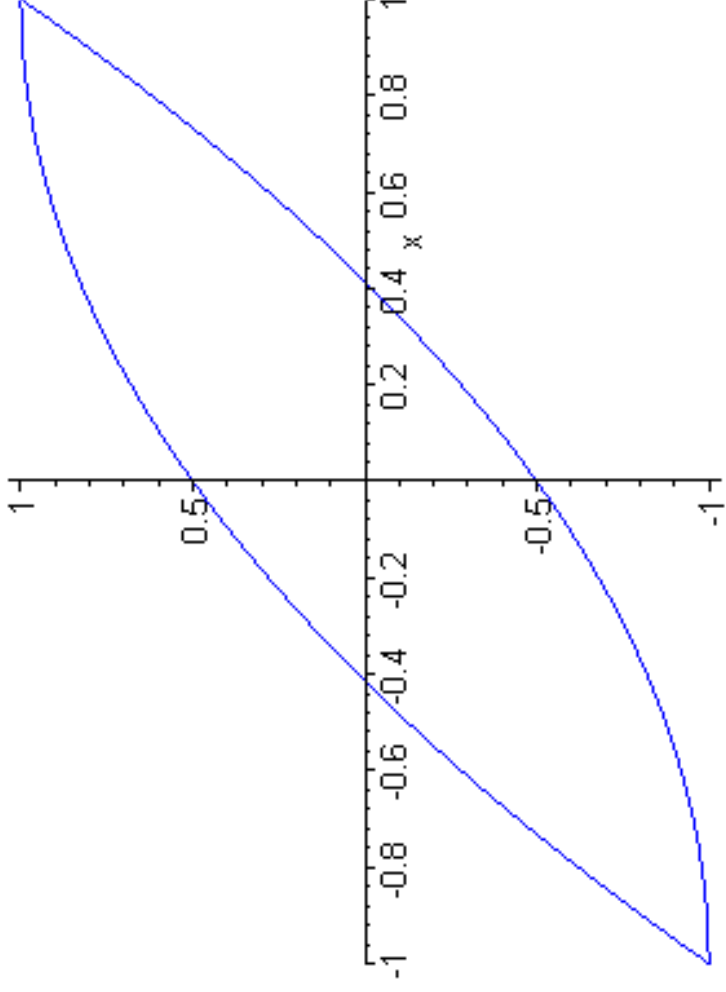

Result of finite-element minimization, minimizing $I(u_h)$ for a piecewise affine approximation u_h to u on a mesh of size h , when h is very small. The method converges and produces two curves u^\pm .

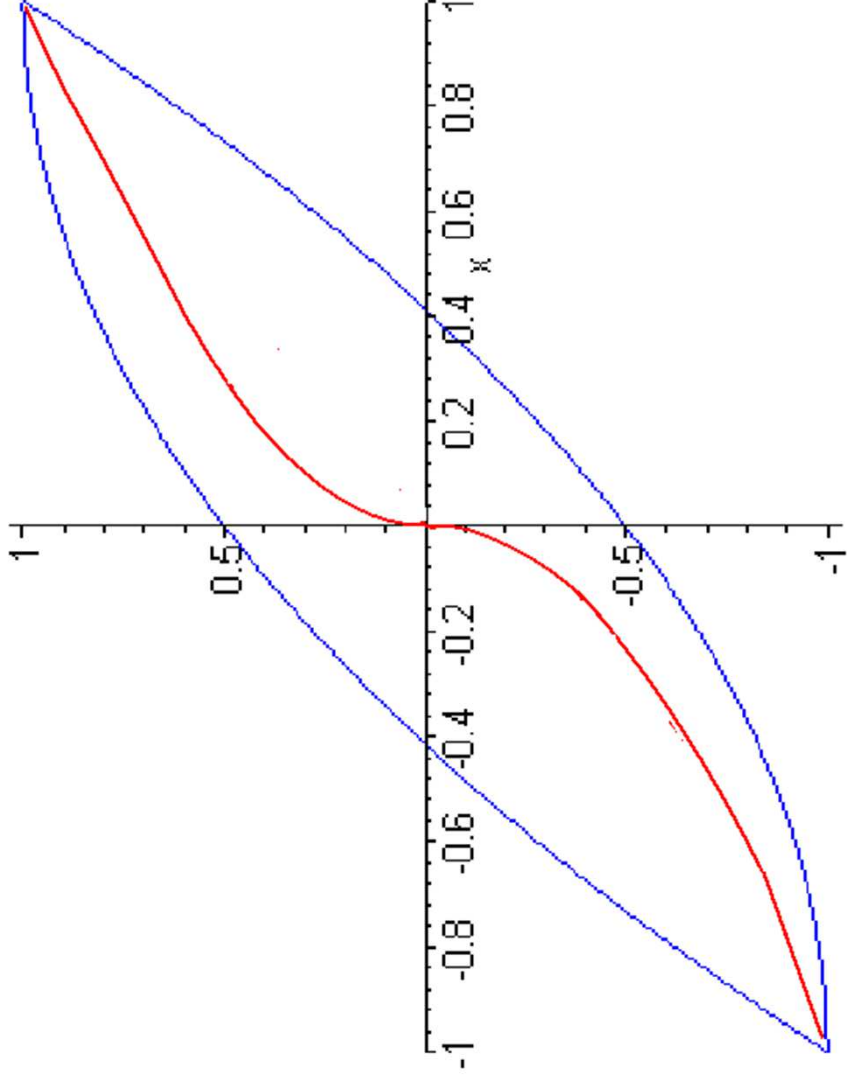

However the real minimizer is u^* , which has a singularity

$$u^*(x) \sim |x|^{\frac{2}{3}} \text{sign } x \text{ as } x \sim 0.$$

Since u_x^* is unbounded, it does not satisfy the (weak form of) the Euler Lagrange equation, namely

$$f_{u_x} = \int_0^x f_u + \text{constant}.$$

Note that this equation is elliptic, since $f_{u_x u_x} \geq 2\epsilon$, so that any weak solution is smooth.

Moreover the Lavrentiev phenomenon holds:

$$\inf_A I = I(u^*) < \inf_{A \cap C^\infty} I = I(u^\pm),$$

where $A = \{u \in W^{1,1}(-1, 1) : u(\pm 1) = \pm 1\}$.

For this problem one has that

$$I(u^* + t\varphi) = \infty \text{ for } t \neq 0, \text{ if } \varphi(0) \neq 0.$$

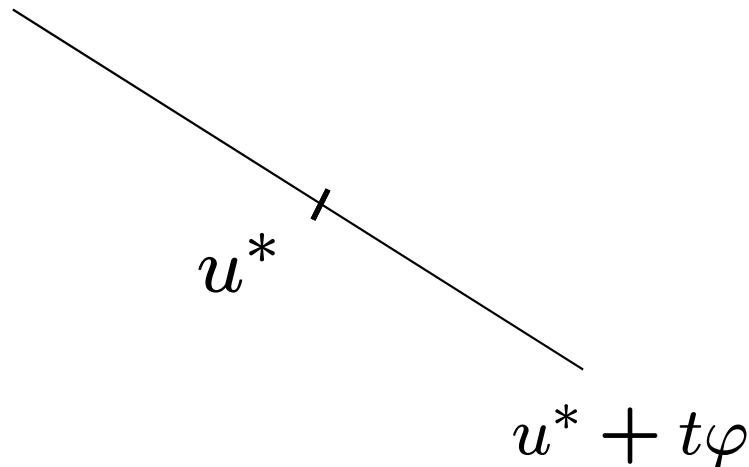

Also if $u^{(j)} \in W^{1,\infty}$ converges a.e. to u^* then

$$I(u^{(j)}) \rightarrow \infty$$

(the repulsion property), explaining the numerical results.

Derivation of the EL equation for 1D elasticity

Theorem 3

Let (H1) and (H5) hold and suppose further that W_p exists and is continuous in $(x, p) \in [0, 1] \times (0, \infty)$, and that h_y exists and is continuous in $(x, y) \in [0, 1] \times \mathbf{R}$. If y minimizes I in \mathcal{A} then $W_p(\cdot, y_x(\cdot)) \in C^1([0, 1])$ and

$$\frac{d}{dx} W_p(x, y_x(x)) = h_y(x, y(x)) \text{ for all } x \in [0, 1]. \text{ (EL)}$$

Proof.

Pick any representative of y_x and let

$\Omega_j = \{x \in [0, 1] : \frac{1}{j} \leq y_x(x) \leq j\}$. Then Ω_j is measurable, $\Omega_j \subset \Omega_{j+1}$ and $\text{meas} \left([0, 1] \setminus \bigcup_{j=1}^{\infty} \Omega_j \right) = 0$.

Given j , let $z \in L^\infty(0, 1)$ with $\int_{\Omega_j} z \, dx = 0$. For $|\varepsilon|$ sufficiently small define $y^\varepsilon \in W^{1,1}(0, 1)$ by

$$y_x^\varepsilon(x) = y_x(x) + \varepsilon \chi_j(x) z(x), \quad y^\varepsilon(0) = \alpha,$$

where χ_j is the characteristic function of Ω_j .

Then

$$\begin{aligned} & \frac{d}{d\varepsilon} I(y^\varepsilon) |_{\varepsilon=0} \\ &= \int_{\Omega} \left[W_p(x, y_x) z + h_y \int_0^x \chi_j z \, ds \right] dx \\ &= \int_{\Omega_j} \left[W_p(x, y_x) - \int_0^x h_y(s, y(s)) \, ds \right] z(x) \, dx \\ &= 0. \end{aligned}$$

Hence

$$W_p(x, y_x) - \int_0^x h_y(s, y(s)) \, ds = C_j \text{ in } \Omega_j,$$

and clearly C_j is independent of j .

Corollary 1

Let the hypotheses of Theorem 3 hold and assume further that

$$\lim_{p \rightarrow 0^+} \max_{x \in [0,1]} W_p(x, p) = -\infty \quad (*).$$

Then there exists $\mu > 0$ such that

$$y_x(x) \geq \mu > 0 \text{ a.e. } x \in [0, 1].$$

Proof.

$$W_p(x, y_x(x)) \geq C > -\infty \text{ by (EL).}$$

Remark.

(*) is satisfied if $W(x, p)$ is convex in p for all $x \in [0, 1]$, $0 < p \leq \varepsilon$ for some $\varepsilon > 0$ and if

$$(H1+) \quad \lim_{p \rightarrow 0+} \min_{x \in [0, 1]} W(x, p) = \infty.$$

Proof.

$$W_p(x, p) \leq \frac{W(x, \varepsilon) - W(x, p)}{\varepsilon - p}.$$

Corollary 2.

If (*), (H3) and the hypotheses of Theorem 3 hold, and if $W(x, \cdot)$ is strictly convex then y has a representative in $C^1([0, 1])$.

Proof.

$W_p(x, y_x(x))$ has a continuous representative. So there is a subset $S \subset [0, 1]$ of full measure such that $W_p(x, y_x(x))$ is continuous on S . We need to show that if $\{x_j\}, \{\tilde{x}_j\} \subset S$ with $x_j \rightarrow x, \tilde{x}_j \rightarrow x$ then the limits $\lim_{j \rightarrow \infty} y_x(x_j), \lim_{j \rightarrow \infty} y_x(\tilde{x}_j)$ exist and are finite and equal.

By (H3) and convexity,

$\lim_{p \rightarrow \infty} \min_{x \in [0,1]} W_p(x, p) = \infty$. Hence we may assume that $y_x(x_j) \rightarrow z, y_x(\tilde{x}_j) \rightarrow \tilde{z} \in [\mu, \infty)$ with $z \neq \tilde{z}$. Hence $W_p(x, z) = W_p(x, \tilde{z})$, which by strict convexity implies $z = \tilde{z}$.

Existence of minimizers in 3D elastostatics

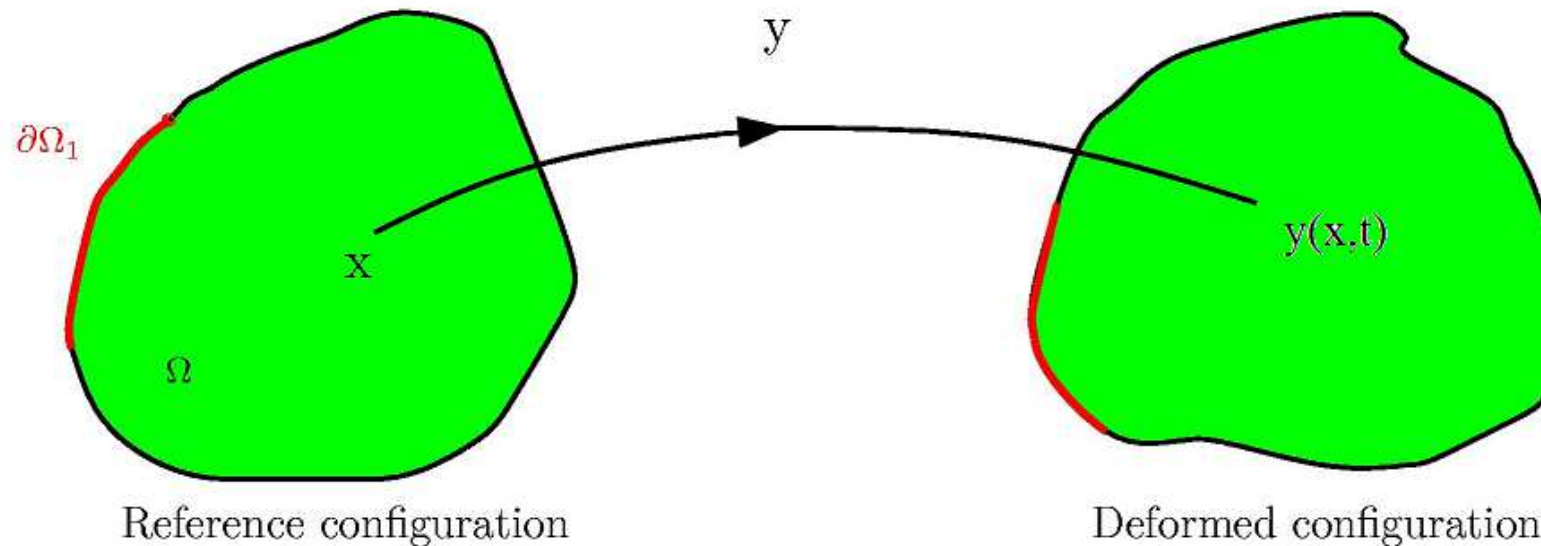

$\Omega \subset \mathbf{R}^3$ bounded domain with Lipschitz boundary $\partial\Omega$, $\partial\Omega_1 \subset \partial\Omega$ relatively open, $\bar{y} : \partial\Omega_1 \rightarrow \mathbf{R}^3$ measurable.

Minimize

$$I(y) = \int_{\Omega} W(Dy) dx$$

in

$$\mathcal{A} = \{y \in W^{1,1} : \det Dy(x) > 0 \text{ a.e.}, y|_{\partial\Omega_1} = \bar{y}\}.$$

(Note that we have for the time being replaced the invertibility condition by the local condition $\det Dy(x) > 0$ a.e., which is easier to handle.)

So far we have assumed that $W : M_+^{3 \times 3} \rightarrow [0, \infty)$ is continuous, and that

$$(H1) \quad W(F) \rightarrow \infty \text{ as } \det F \rightarrow 0+,$$

so that setting $W(F) = \infty$ if $\det F \leq 0$, we have that $W : M^{3 \times 3} \rightarrow [0, \infty]$ is continuous, and that W is *frame-indifferent*, i.e.

$$(H2) \quad W(RF) = W(F) \text{ for all } R \in \text{SO}(3), F \in M^{3 \times 3}.$$

(In fact (H2) plays no direct role in the existence theory.)

Growth condition

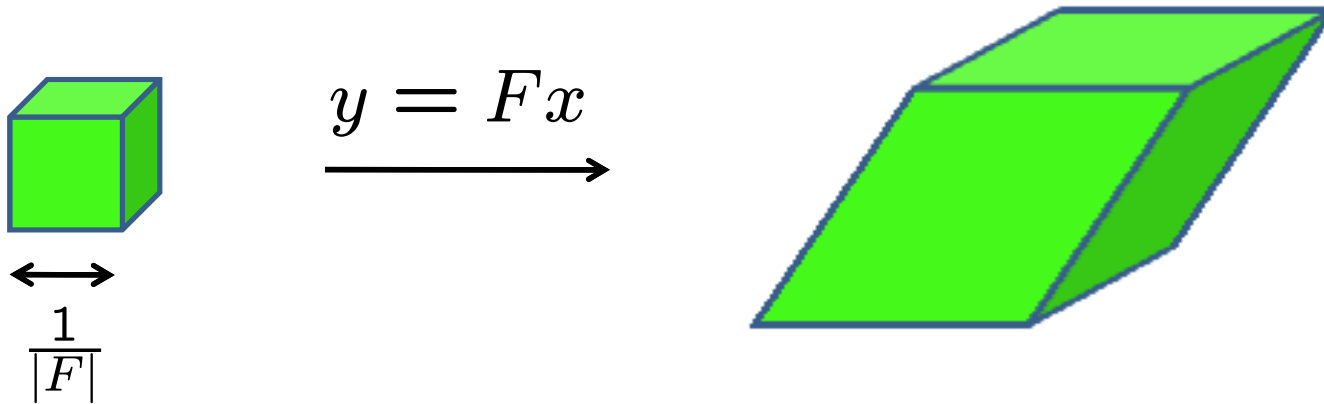

$$\lim_{|F| \rightarrow \infty} \frac{W(F)}{|F|^3} = \infty$$

says that you can't get a finite line segment from an infinitesimal cube with finite energy.

We will use growth conditions a little weaker than this. Note that if

$$W(F) \geq C(1 + |F|^{3+\varepsilon})$$

then any deformation with finite elastic energy

$$\int_{\Omega} W(Dy(x)) dx$$

is in $W^{1,3+\varepsilon}$ and so is continuous.

Convexity conditions

The key difficulty is that W is **never convex**, so that we can't use the same method to prove existence of minimizers as in 1D.

Reasons

1. Convexity of W is inconsistent with (H1) because $M_+^{3 \times 3}$ is not convex.

Remark: $M_+^{3 \times 3}$ is not simply-connected.

$$A = \text{diag}(1, 1, 1)$$

$$W\left(\frac{1}{2}(A + B)\right) = \infty > \frac{1}{2}W(A) + \frac{1}{2}W(B)$$

$$\frac{1}{2}(A + B) = \text{diag}(0, 0, 1)$$

$$\det F > 0$$

$$B = \text{diag}(-1, -1, 1)$$

$$\det F < 0$$

2. If W is convex, then any equilibrium solution (solution of the EL equations) is an absolute minimizer of the elastic energy

$$I(y) = \int_{\Omega} W(Dy) dx.$$

Proof.

$$I(z) = \int_{\Omega} W(Dz) dx \geq \int_{\Omega} [W(Dy) + DW(Dy) \cdot (Dz - Dy)] dx = I(y).$$

This contradicts common experience of nonunique equilibria, e.g. buckling.

Examples of nonunique equilibrium solutions

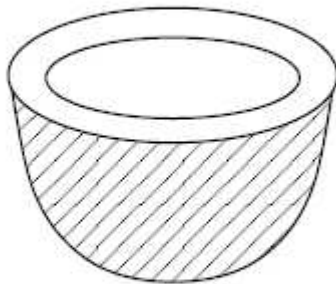
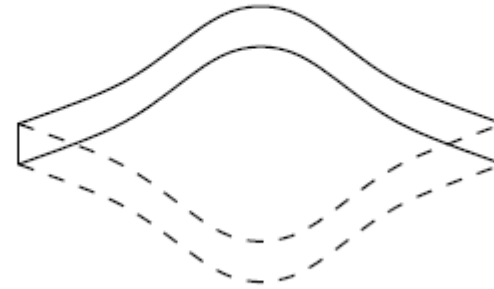
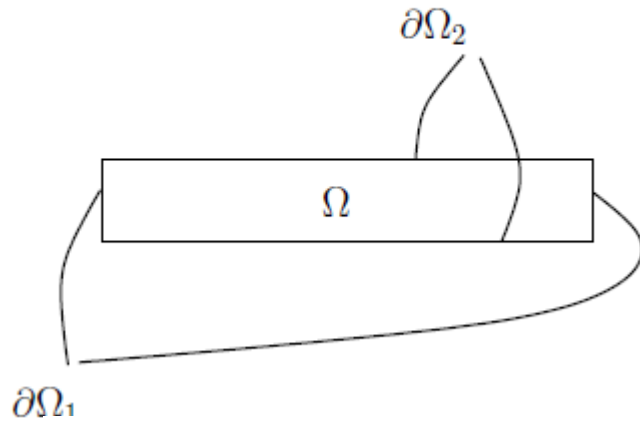

↑
push

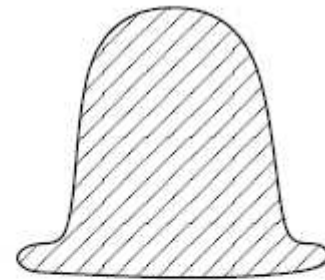

Pure zero traction problem.

For an isotropic material could we assume instead that $\Phi(v_1, v_2, v_3)$ is convex in the principal stretches v_1, v_2, v_3 ?

This is a consequence of the *Coleman-Noll inequality*. While it is consistent with (H1) it is not in general satisfied for rubber-like materials, which are almost incompressible ($v_1 v_2 v_3 = 1$), and so have nonconvex sublevel sets.

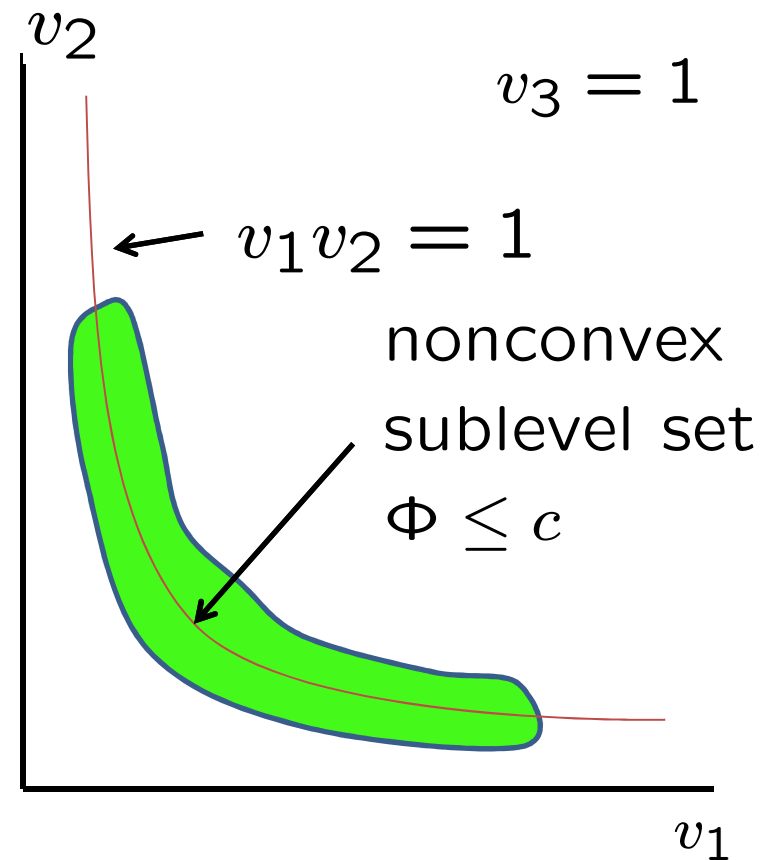

Rank-one matrices and the Hadamard jump condition

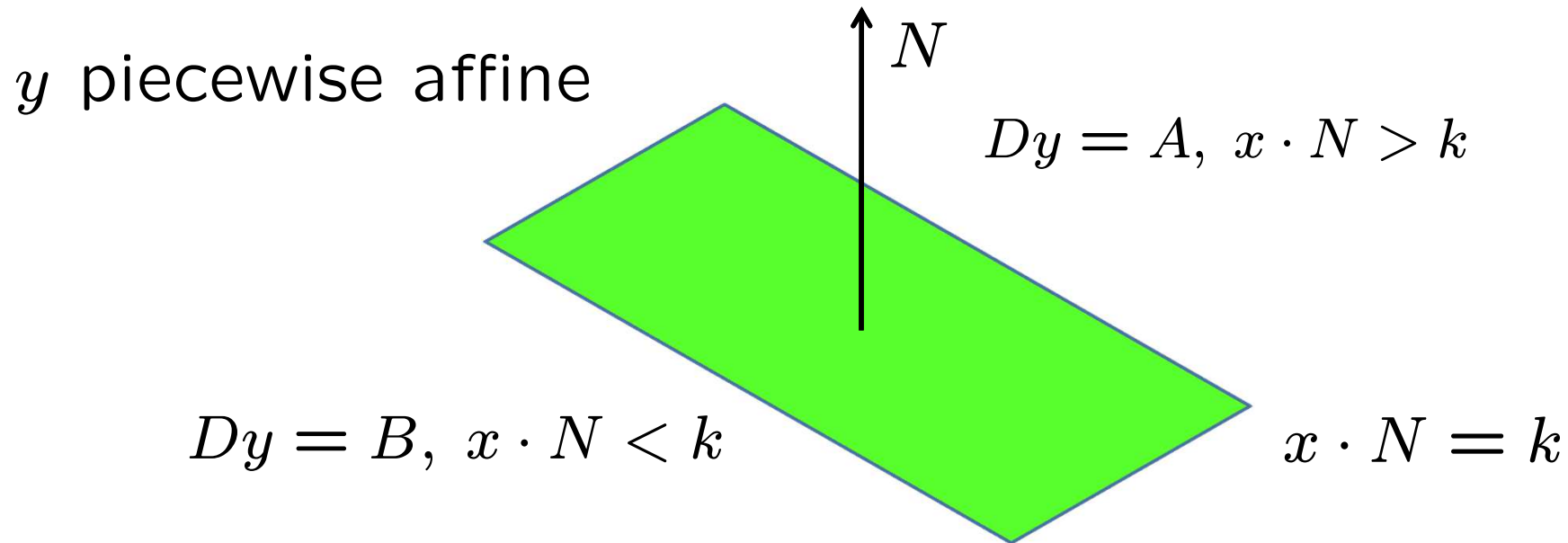

Let $C = A - B$. Then $Cx = 0$ if $x \cdot N = 0$.
 Thus $C(z - (z \cdot N)N) = 0$ for all z , and so
 $Cz = (CN \otimes N)z$. Hence

$$\boxed{A - B = a \otimes N}$$

Hadamard
jump condition

More generally this holds for y piecewise C^1 , with Dy jumping across a C^1 surface.

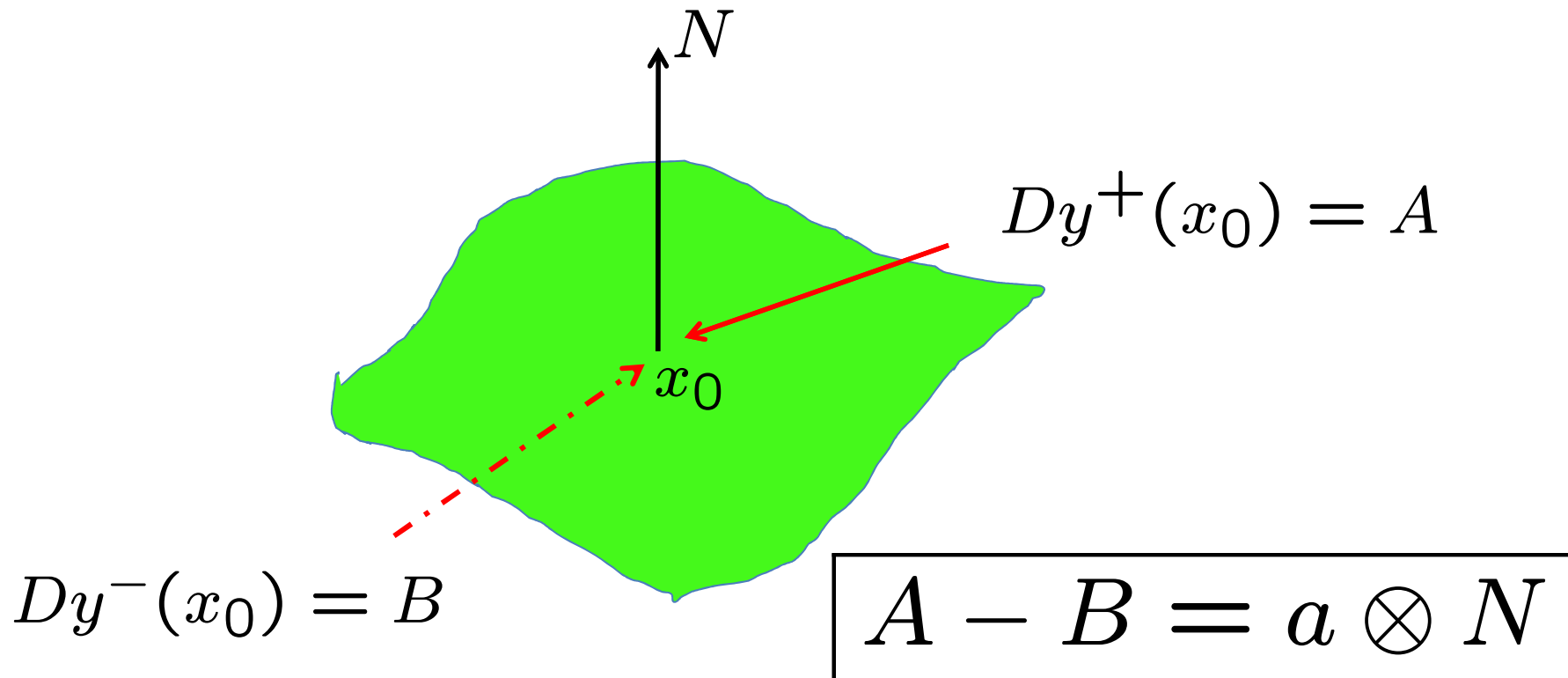

Exercise: prove this by blowing up around x using $y_\varepsilon(x) = \varepsilon y\left(\frac{x-x_0}{\varepsilon}\right)$.

Rank-one convexity

W is *rank-one convex* if the map $t \mapsto W(F + ta \otimes N)$ is convex for each $F \in M^{3 \times 3}$ and $a \in \mathbf{R}^3, N \in \mathbf{R}^3$.

(Same definition for $M^{m \times n}$.)

Equivalently,

$$W(\lambda F + (1 - \lambda)G) \leq \lambda W(F) + (1 - \lambda)W(G)$$

if $F, G \in M^{3 \times 3}$ with $F - G = a \otimes N$ and $\lambda \in (0, 1)$.

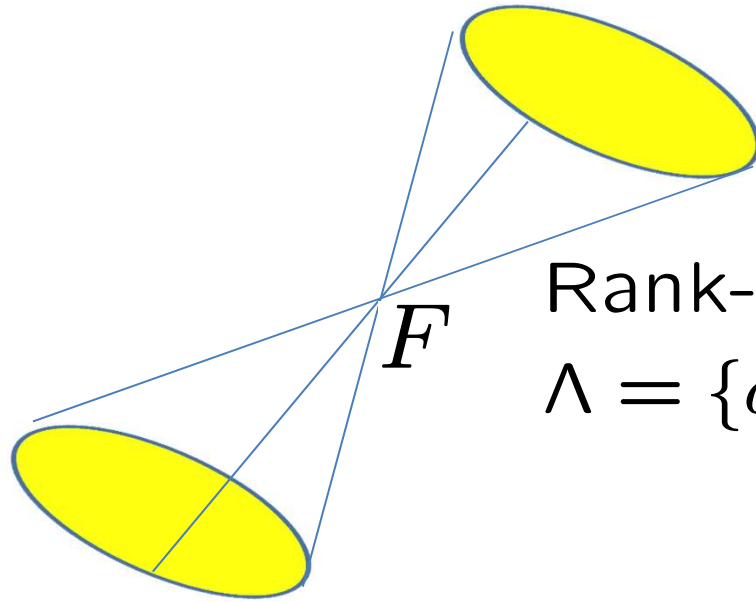

Rank-one cone

$$\Lambda = \{a \otimes N : a, N \in \mathbf{R}^3\}$$

Rank-one convexity is consistent with (H1) because $\det(F + ta \otimes N)$ is linear in t , so that $M_+^{3 \times 3}$ is rank-one convex

(i.e. if $F, G \in M_+^{3 \times 3}$ with $F - G = a \otimes N$ then $\lambda F + (1 - \lambda)G \in M_+^{3 \times 3}$.)

A specific example of a rank-one convex W is an *elastic fluid* for which

$$W(F) = h(\det F),$$

with h convex and $\lim_{\delta \rightarrow 0^+} h(\delta) = \infty$.

Such a W is rank-one convex because if $F, G \in M_+^{3 \times 3}$ with $F - G = a \otimes N$, and $\lambda \in (0, 1)$ then

$$\begin{aligned} W(\lambda F + (1 - \lambda)G) &= h(\lambda \det F + (1 - \lambda) \det G) \\ &\leq \lambda h(\det F) + (1 - \lambda)h(\det G) \\ &= \lambda W(F) + (1 - \lambda)W(G). \end{aligned}$$

If $W \in C^1(M_+^{3 \times 3})$ then W is rank-one convex iff $t \mapsto DW(F + ta \otimes N) \cdot a \otimes N$ is nondecreasing.

The linear map

$$y(x) = (F + ta \otimes N)x = Fx + ta(x \cdot N)$$

represents a shear relative to Fx parallel to a plane Π with normal N in the reference configuration, in the direction a . The corresponding stress vector across the plane Π is

$$t_R = DW(F + ta \otimes N)N,$$

and so rank-one convexity says that the component $t_R \cdot a$ in the direction of the shear is monotone in the magnitude of the shear.

If $W \in C^2(M_+^{3 \times 3})$ then W is rank-one convex iff

$$\frac{d^2}{dt^2} W(F + ta \otimes N)|_{t=0} \geq 0,$$

for all $F \in M_+^{3 \times 3}$, $a, N \in \mathbf{R}^3$, or equivalently

$$D^2W(F)(a \otimes N, a \otimes N) = \frac{\partial^2 W(F)}{\partial F_{i\alpha} \partial F_{j\beta}} a_i N_\alpha a_j N_\beta \geq 0,$$

(Legendre-Hadamard condition).

The strengthened version

$$D^2W(F)(a \otimes N, a \otimes N) = \frac{\partial^2 W(F)}{\partial F_{i\alpha} \partial F_{j\beta}} a_i N_\alpha a_j N_\beta \geq \mu |a|^2 |N|^2,$$

for all F, a, N and some constant $\mu > 0$ is called *strong ellipticity*.

One consequence of strong ellipticity is that it implies the reality of wave speeds for the equations of elastodynamics linearized around a uniform state $y = Fx$.

Equation of motion of pure elastodynamics

$$\rho_R \ddot{y} = \text{Div } DW(Dy),$$

where ρ_R is the (constant) density in the reference configuration.

Linearized around the uniform state $y = Fx$ the equations become

$$\rho_R \ddot{u}_i = \frac{\partial^2 W(F)}{\partial F_{i\alpha} \partial F_{j\beta}} u_{j,\alpha\beta}.$$

The plane wave

$$u = af(x \cdot N - ct)$$

is a solution if

$$C(F)a = c^2 \rho_R a,$$

where

$$C_{ij} = \frac{\partial^2 W(F)}{\partial F_{i\alpha} \partial F_{j\beta}} N_\alpha N_\beta.$$

Since $C(F) > 0$ by strong ellipticity, it follows that $c^2 > 0$ as claimed.

Quasiconvexity (C.B. Morrey, 1952)

Let $W : M^{m \times n} \rightarrow [0, \infty]$ be Borel measurable. W is said to be *quasiconvex at* $F \in M^{m \times n}$ if the inequality

$$\int_{\Omega} W(F + D\varphi(x)) \, dx \geq \int_{\Omega} W(F) \, dx$$

holds for any $\varphi \in W_0^{1, \infty}(\Omega; \mathbf{R}^m)$, and is *quasi-convex* if it is quasiconvex at every $F \in M^{m \times n}$.

Here $\Omega \subset \mathbf{R}^n$ is any bounded open set whose boundary $\partial\Omega$ has zero n -dimensional Lebesgue measure.

Remark

$W_0^{1,\infty}(\Omega; \mathbf{R}^m)$ is defined as the closure of $C_0^\infty(\Omega; \mathbf{R}^m)$ in the weak* topology of $W^{1,\infty}(\Omega; \mathbf{R}^m)$ (and not in the norm topology - why?). That is $\varphi \in W_0^{1,\infty}(\Omega; \mathbf{R}^m)$ if there exists a sequence $\varphi^{(j)} \in C_0^\infty(\Omega; \mathbf{R}^m)$ such that $\varphi^{(j)} \xrightarrow{*} \varphi$, $D\varphi^{(j)} \xrightarrow{*} D\varphi$ in L^∞ .

Sometimes the definition is given with C_0^∞ replacing $W_0^{1,\infty}$. This is the same if W is finite and continuous, but it is not clear (to me) if it is the same if W is continuous and takes the value $+\infty$.

Setting $m = n = 3$ we see that W is quasiconvex if for any $F \in M^{3 \times 3}$ the pure displacement problem to minimize

$$I(y) = \int_{\Omega} W(Dy(x)) dx$$

subject to the linear boundary condition

$$y(x) = Fx, \quad x \in \partial\Omega,$$

has $y(x) = Fx$ as a minimizer.

Proposition 3

Quasiconvexity is independent of Ω .

Proof. Suppose the definition holds for Ω , and let Ω_1 be another bounded open subset of \mathbf{R}^n such that $\partial\Omega_1$ has n -dimensional measure zero. By the Vitali covering theorem we can write Ω as a disjoint union

$$\Omega = \bigcup_{i=1}^{\infty} (a_i + \varepsilon_i \Omega_1) \cup N,$$

where N is of zero measure.

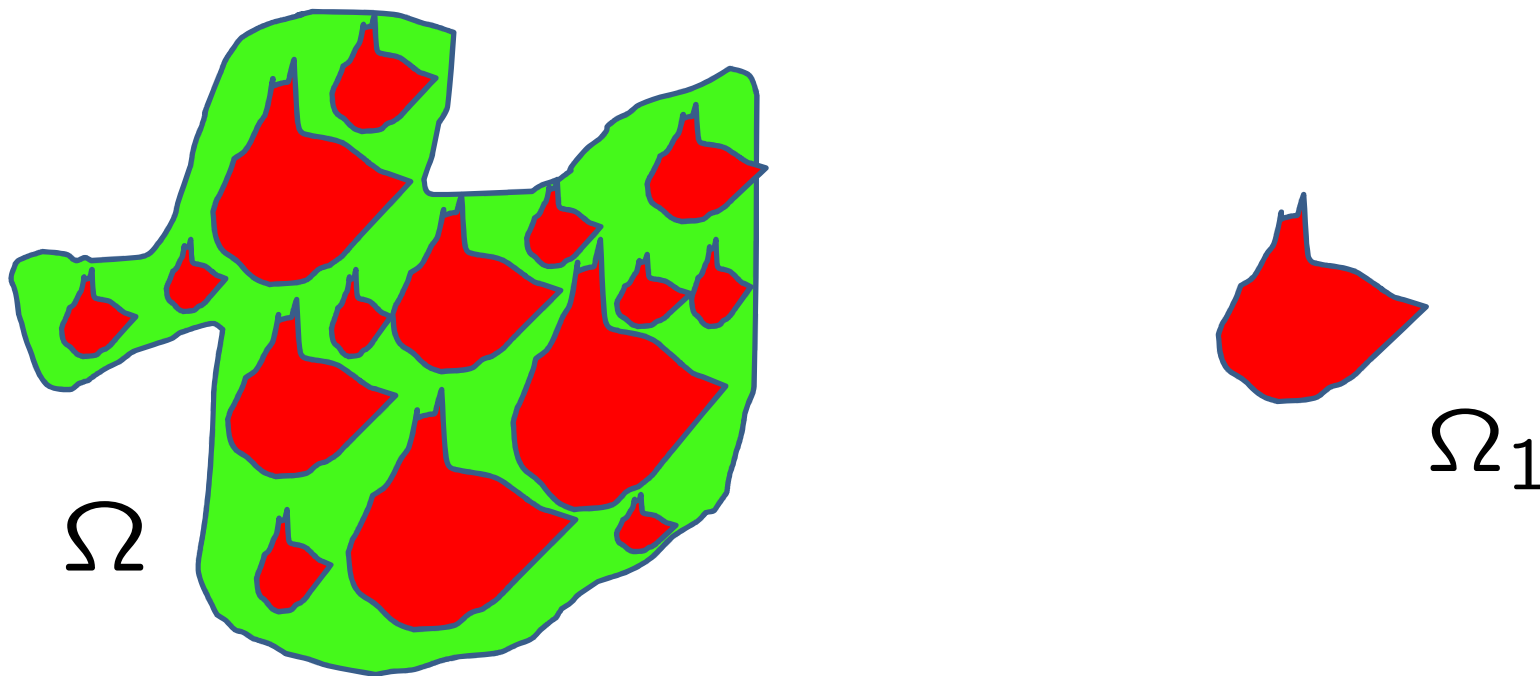

Let $\varphi \in W_0^{1,\infty}(\Omega_1; \mathbf{R}^m)$ and define

$$\tilde{\varphi}(x) = \begin{cases} \varepsilon_i \varphi\left(\frac{x-a_i}{\varepsilon_i}\right) & \text{for } x \in a_i + \varepsilon_i \Omega_1 \\ 0 & \text{otherwise} \end{cases} .$$

Then $\tilde{\varphi} \in W_0^{1,\infty}(\Omega; \mathbf{R}^m)$ and

$$\begin{aligned} & \int_{\Omega} W(F + D\varphi(x)) \, dx \\ &= \sum_{i=1}^{\infty} \int_{a_i + \varepsilon_i \Omega_1} W\left(F + D\varphi\left(\frac{x - a_i}{\varepsilon_i}\right)\right) \, dx \\ &= \left(\sum_{i=1}^{\infty} \varepsilon_i^n\right) \int_{\Omega_1} W(F + D\varphi(x)) \, dx \\ &= \left(\frac{\text{meas } \Omega}{\text{meas } \Omega_1}\right) \int_{\Omega_1} W(F + D\varphi(x)) \, dx \\ &\geq (\text{meas } \Omega) W(F). \end{aligned}$$

Another form of the definition that is equivalent for finite continuous W is that

$$\int_Q W(Dy) dx \geq (\text{meas } Q)W(F)$$

for any $y \in W^{1,\infty}$ such that Dy is the restriction to a cube Q (e.g. $Q = (0, 1)^n$) of a Q -periodic map on \mathbf{R}^n with $\frac{1}{\text{meas } Q} \int_Q Dy dx = F$.

One can even replace periodicity with almost periodicity (see J.M. Ball, J.C. Currie, and P.J. Olver. Null Lagrangians, weak continuity, and variational problems of arbitrary order. *J. Functional Anal.*, 41:135–174, 1981).

Theorem 4

If W is continuous and quasiconvex then W is rank-one convex.

Remark

This is not true in general if W is not continuous. As an example, define for given nonzero a, N

$$W(0) = W(a \otimes N) = 0, W(F) = \infty \text{ otherwise.}$$

Then W is clearly not rank-one convex, but it is quasiconvex because given $F \neq 0, a \otimes N$ there is no $\varphi \in W_0^{1,\infty}$ with $F + D\varphi(x) \in \{0, a \otimes N\}$

Proof

We prove that

$$W(F) \leq \lambda W(F - (1 - \lambda)a \otimes N) + (1 - \lambda)W(F + \lambda a \otimes N)$$

for any $F \in M^{m \times n}$, $a \in \mathbf{R}^m$, $N \in \mathbf{R}^n$, $\lambda \in (0, 1)$.

Without loss of generality we suppose that $N = e_1$. We follow an argument of Morrey.

Let $D = (-(1 - \lambda), \lambda) \times (-\rho, \rho)^{n-1}$ and let D_j^\pm be the pyramid that is the convex hull of the origin and the face of D with normal $\pm e_j$.

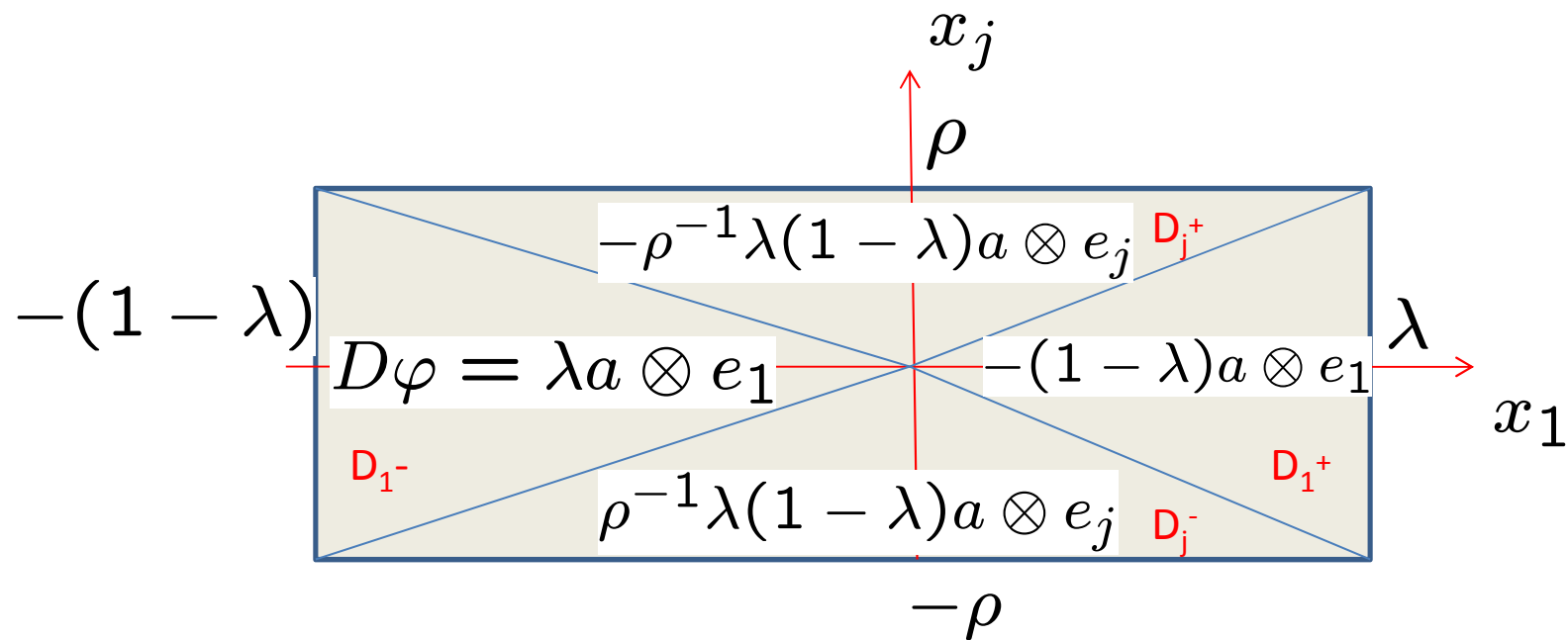

Let $\varphi \in W_0^{1,\infty}(D; \mathbf{R}^m)$ be affine in each D_j^\pm with $\varphi(0) = \lambda(1-\lambda)a$.

The values of $D\varphi$ are shown.

By quasiconvexity

$$\begin{aligned}
(2\rho)^{n-1}W(F) &\leq \frac{(2\rho)^{n-1}\lambda}{n}W(F - (1 - \lambda)a \otimes e_1) \\
&\quad + \frac{(2\rho)^{n-1}(1 - \lambda)}{n}W(F + \lambda a \otimes e_1) \\
&\quad + \sum_{j=2}^n \frac{(2\rho)^{n-1}}{2n} [W(F + \rho^{-1}\lambda(1 - \lambda)a \otimes e_j) \\
&\quad \quad \quad + W(F - \rho^{-1}\lambda(1 - \lambda)a \otimes e_j)]
\end{aligned}$$

Suppose $W(F) < \infty$. Then dividing by $(2\rho)^{n-1}$, letting $\rho \rightarrow 0+$ and using the continuity of W , we obtain

$$W(F) \leq \lambda W(F - (1 - \lambda)a \otimes e_1) + (1 - \lambda)W(F + \lambda a \otimes e_1)$$

as required.

Now suppose that $W(F - (1 - \lambda)a \otimes e_1)$ and $W(F + \lambda a \otimes e_1)$ are finite. Then $g(\tau) = W(F + \tau a \otimes e_1)$ lies below the chord joining the points $(-(1 - \lambda), g(-(1 - \lambda)))$, $(\lambda, g(\lambda))$ whenever $g(\tau) < \infty$, and since g is continuous it follows that $g(0) = W(F) < \infty$.

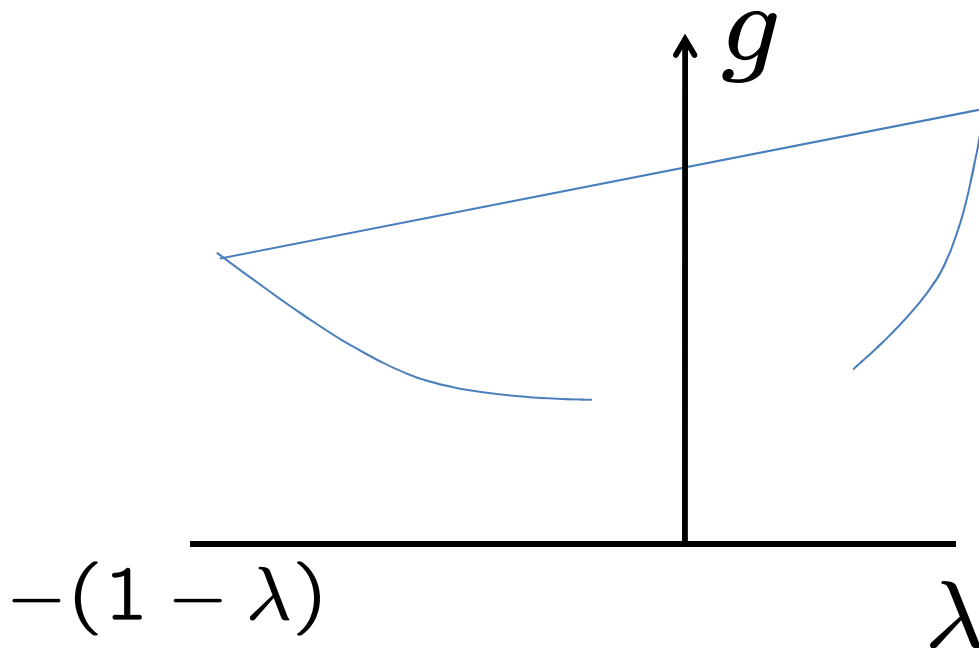

Corollary 3

If $m = 1$ or $n = 1$ then a continuous $W : M^{m \times n} \rightarrow [0, \infty]$ is quasiconvex iff it is convex.

Proof.

If $m = 1$ or $n = 1$ then rank-one convexity is the same as convexity. If W is convex (for any dimensions) then W is quasiconvex by Jensen's inequality:

$$\begin{aligned} & \frac{1}{\text{meas } \Omega} \int_{\Omega} W(F + D\varphi) dx \\ & \geq W \left(\frac{1}{\text{meas } \Omega} \int_{\Omega} (F + D\varphi) dx \right) = W(F). \end{aligned}$$

Theorem 5

Let $W : M^{m \times n} \rightarrow [0, \infty]$ be Borel measurable, and $\Omega \subset \mathbf{R}^n$ a bounded open set. A necessary condition for

$$I(y) = \int_{\Omega} W(Dy) dx$$

to be sequentially weak* lower semicontinuous on $W^{1,\infty}(\Omega; \mathbf{R}^m)$ is that W is quasiconvex.

Proof.

Let $F \in M^{m \times n}$, $\varphi \in W_0^{1,\infty}(Q; \mathbf{R}^m)$, where $Q = (0, 1)^n$.

Given k write Ω as the disjoint union

$$\Omega = \bigcup_{j=1}^{\infty} (a_j^{(k)} + \varepsilon_j^{(k)} Q) \cup N_k,$$

where $a_j^{(k)} \in \mathbf{R}^m$, $|\varepsilon_j^{(k)}| < 1/k$, $\text{meas } N_k = 0$, and define

$$y^{(k)}(x) = \begin{cases} Fx + \varepsilon_j^{(k)} \varphi \left(\frac{x - a_j^{(k)}}{\varepsilon_j^{(k)}} \right) & \text{for } x \in a_j^{(k)} + \varepsilon_j^{(k)} Q \\ Fx & \text{otherwise} \end{cases} .$$

Then $y^{(k)} \xrightarrow{*} Fx$ in $W^{1,\infty}$ as $k \rightarrow \infty$ and so

$$(\text{meas } \Omega)W(F) \leq \liminf_{k \rightarrow \infty} I(y^{(k)})$$

$$= \sum_{j=1}^{\infty} \int_{a_j^{(k)} + \varepsilon_j^{(k)} Q} W\left(F + D\varphi\left(\frac{x - a_j^{(k)}}{\varepsilon_j^{(k)}}\right)\right) dx$$

$$= \sum_{j=1}^{\infty} \varepsilon_j^{(k)n} \int_Q W(F + D\varphi) dx$$

$$= \left(\frac{\text{meas } \Omega}{\text{meas } Q}\right) \int_Q W(F + D\varphi) dx$$

Theorem 6 (Morrey, Acerbi-Fusco, Marcellini)

Let $\Omega \subset \mathbf{R}^n$ be bounded and open. Let

$W : M^{m \times n} \rightarrow [0, \infty)$ be quasiconvex and let $1 \leq p \leq \infty$. If $p < \infty$ assume that

$$0 \leq W(F) \leq c(1 + |F|^p) \text{ for all } F \in M^{m \times n}.$$

Then

$$I(y) = \int_{\Omega} W(Dy) dx$$

is sequentially weakly lower semicontinuous (weak* if $p = \infty$) on $W^{1,p}$.

Proof omitted. Unfortunately the growth condition conflicts with (H1), so we can't use this to prove existence in 3D elasticity.

Theorem 7 (Ball & Murat)

Let $W : M^{m \times n} \rightarrow [0, \infty]$ be Borel measurable, and let $\Omega \subset \mathbf{R}^n$ be bounded open and have boundary of zero n -dimensional measure. If

$$I(y) = \int_{\Omega} [W(Dy) + h(x, y)] dx$$

attains an absolute minimum on $\mathcal{A} = \{y : y - Fx \in W_0^{1,1}(\Omega; \mathbf{R}^m)\}$ for all F and all smooth nonnegative h , then W is quasiconvex.

Proof (Exercise: use the same method as Theorem 2 and Vitali.)

Theorem 8 (van Hove)

Let $W(F) = c_{ijkl}F_{ij}F_{kl}$ be quadratic. Then W is rank-one convex $\Leftrightarrow W$ is quasiconvex.

Proof.

Let W be rank-one convex. Since for any $\varphi \in W_0^{1,\infty}$

$$\int_{\Omega} [W(F + D\varphi) - W(F)] dx = \int_{\Omega} c_{ijkl} \varphi_{i,j} \varphi_{k,l} dx$$

we just need to show that the RHS is ≥ 0 .

Extend φ by zero to the whole of \mathbf{R}^n and take Fourier transforms.

By the Plancherel formula

$$\begin{aligned} \int_{\Omega} c_{ijkl} \varphi_{i,j} \varphi_{k,l} dx &= \int_{\mathbf{R}^n} c_{ijkl} \varphi_{i,j} \varphi_{k,l} dx \\ &= 4\pi^2 \int_{\mathbf{R}^n} \operatorname{Re} [c_{ijkl} \hat{\varphi}_i \xi_j \bar{\hat{\varphi}}_k \xi_l] d\xi \\ &\geq 0 \end{aligned}$$

as required.

Null Lagrangians

When does equality hold in the quasiconvexity condition? That is, for what L is

$$\int_{\Omega} L(F + D\varphi(x)) dx = \int_{\Omega} L(F) dx$$

for all $\varphi \in W_0^{1,\infty}(\Omega; \mathbf{R}^m)$? We call such L *quasiaffine*.

Theorem 9 (Landers, Morrey, Reshetnyak ...)

If $L : M^{m \times n} \rightarrow \mathbf{R}$ is continuous then the following are equivalent:

(i) L is quasiaffine.

(ii) L is a (smooth) *null Lagrangian*, i.e. the Euler-Lagrange equations $\text{Div } D_F L(Du) = 0$ hold for *all* smooth u .

(iii) $L(F) = \text{constant} + \sum_{k=1}^{d(m,n)} c_k J_k(F)$,

where $\mathbf{J}(F) = (J_1(F), \dots, J_{d(m,n)}(F))$ consists of all the minors of F . (e.g. $m = n = 3$:

$L(F) = \text{const.} + C \cdot F + D \cdot \text{cof } F + e \det F$).

(iv) $u \mapsto L(Du)$ is sequentially weakly continuous from $W^{1,p} \rightarrow L^1$ for sufficiently large p ($p > \min(m, n)$ will do).

Ideas of proofs.

(i) \Rightarrow (iii) use L rank-one affine (Theorem 4).

(iii) \Rightarrow (iv) Take e.g.

$$\begin{aligned} J(Du) &= u_{1,1}u_{2,2} - u_{1,2}u_{2,1} \\ &= (u_1u_{2,2})_{,1} - (u_1u_{2,1})_{,2} \end{aligned}$$

if u is smooth.

So if $\varphi \in C_0^\infty(\Omega)$

$$\int_{\Omega} J(Du) \cdot \varphi \, dx = \int_{\Omega} [u_1u_{2,1}\varphi_{,2} - u_1u_{2,2}\varphi_{,1}] \, dx.$$

True for $u \in W^{1,2}$ by approximation.

If $u^{(j)} \rightharpoonup u$ in $W^{1,p}$, $p > 2$, then

$$\begin{aligned} \int_{\Omega} J(Du^{(j)})\varphi \, dx &= \int_{\Omega} [u_1^{(j)} u_{2,1}^{(j)} \varphi_{,2} - u_1^{(j)} u_{2,2}^{(j)} \varphi_{,1}] \, dx \\ &\rightarrow \int_{\Omega} J(Du)\varphi \, dx \end{aligned}$$

since $u_1^{(j)} \rightarrow u_1$ in $L^{p'}$, $u_{2,1}^{(j)} \rightharpoonup u_{2,1}$ in L^p , and since $J(Du^{(j)})$ is bounded in $L^{p/2}$ it follows that $J(Du^{(j)}) \rightharpoonup J(Du)$ in $L^{p/2}$.

For the higher-order Jacobians we use induction based on the identity

$$\frac{\partial(u_1, \dots, u_m)}{\partial(x_1, \dots, x_m)} = \sum_{s=1}^m (-1)^{s+1} \frac{\partial}{\partial x_s} \left(u_1 \frac{\partial(u_2, \dots, u_m)}{\partial(x_1, \dots, \hat{x}_s, \dots, x_m)} \right)$$

For example, suppose $m = n = 3$, $p \geq 2$,
 $u^{(j)} \rightharpoonup u$ in $W^{1,p}$, $\text{cof } Du^{(j)}$ bounded in $L^{p'}$,
 $\det Du^{(j)} \rightharpoonup \chi$ in L^1 . Then $\chi = \det Du$.

(iv) \Rightarrow (i) by Theorem 5.

(i) \Leftrightarrow (ii)

$$\frac{d}{dt} \int_{\Omega} L(F + D\varphi + tD\psi) dx \Big|_{t=0} = 0$$

for all $\varphi, \psi \in C_0^\infty$

$$\Rightarrow \int_{\Omega} \underbrace{DL(F + D\varphi)}_{Du} \cdot D\psi dx = 0.$$

Polyconvexity

Definition

W is *polyconvex* if there exists a convex function $g : \mathbf{R}^{d(m,n)} \rightarrow (-\infty, \infty]$ such that

$$W(F) = g(\mathbf{J}(F)) \text{ for all } F \in M^{m \times n}.$$

e.g. $W(F) = g(F, \det F)$ if $m = n = 2$,
 $W(F) = g(F, \operatorname{cof} F, \det F)$ if $m = n = 3$,
with g convex.

Theorem 10

Let $W : M^{m \times n} \rightarrow [0, \infty]$ be Borel measurable and polyconvex, with g lower semicontinuous. Then W is quasiconvex.

Proof. Writing

$$\int_{\Omega} f \, dx = \frac{1}{\text{meas } \Omega} \int_{\Omega} f \, dx,$$

$$\begin{aligned} \int_{\Omega} W(F + D\varphi(x)) \, dx &= \int_{\Omega} g(\mathbf{J}(F + D\varphi(x))) \, dx \\ &\stackrel{\text{Jensen}}{\geq} g\left(\int_{\Omega} \mathbf{J}(F + D\varphi) \, dx\right) \\ &= g(\mathbf{J}(F)) \\ &= W(F). \end{aligned}$$

Remark

If $m \geq 3, n \geq 3$ then there are quadratic rank-one convex W that are not polyconvex. Such W cannot be written in the form

$$W(F) = Q(F) + \sum_{l=1}^N \alpha_l J_2^{(l)}(F),$$

where $Q \geq 0$ is quadratic and the $J_2^{(l)}$ are 2×2 minors (Terpstra, D. Serre).

Examples and counterexamples

We have shown that

W convex \Rightarrow W polyconvex \Rightarrow W quasiconvex
 \Rightarrow W rank-one convex.

The reverse implications are all false if $m > 1, n > 1$, except that *it is not known whether W rank-one convex \Rightarrow W quasiconvex when $n \geq m = 2$.*

W polyconvex $\not\Rightarrow$ W convex since any minor is polyconvex.

Example (Dacorogna & Marcellini)

$$m = n = 2$$

$$W_\gamma(F) = |F|^4 - 2\gamma|F|^2 \det F, \quad \gamma \in \mathbf{R},$$

where $|F|^2 = \text{tr}(F^T F)$.

It is not known for what γ the function W_γ is quasiconvex.

$$W_\gamma \text{ is convex} \quad \Leftrightarrow \quad |\gamma| \leq \frac{2}{3}\sqrt{2}$$

$$\text{polyconvex} \quad \Leftrightarrow \quad |\gamma| \leq 1$$

$$\text{quasiconvex} \quad \Leftrightarrow \quad |\gamma| \leq 1 + \varepsilon$$

for some (unknown) $\varepsilon > 0$

$$\text{rank-one convex} \quad \Leftrightarrow \quad |\gamma| \leq \frac{2}{\sqrt{3}} \simeq 1.1547\dots$$

Numerically (Dacorogna-Haeberly)

$$1 + \varepsilon = 1.1547\dots$$

In particular W quasiconvex $\not\Rightarrow$ W polyconvex
(see also later).

Theorem 11 (Sverak 1992)

If $n \geq 2, m \geq 3$ then W rank-one convex $\not\Rightarrow$ W quasiconvex.

Sketch of proof.

It is enough to consider the case $n = 2, m = 3$.

Consider the periodic function $u : \mathbf{R}^2 \rightarrow \mathbf{R}^3$

$$u(x) = \frac{1}{2\pi} \begin{pmatrix} \sin 2\pi x_1 \\ \sin 2\pi x_2 \\ \sin 2\pi(x_1 + x_2) \end{pmatrix}.$$

Then

$$Du(x) = \begin{pmatrix} \cos 2\pi x_1 & 0 \\ 0 & \cos 2\pi x_2 \\ \cos 2\pi(x_1 + x_2) & \cos 2\pi(x_1 + x_2) \end{pmatrix}$$
$$\in L := \left\{ \begin{pmatrix} r & 0 \\ 0 & s \\ t & t \end{pmatrix} : r, s, t \in \mathbf{R} \right\} \text{ a.e.}$$

L is a 3-dimensional subspace of $M^{3 \times 2}$ and the only rank-one lines in L are in the r, s, t directions (i.e. parallel to $\begin{pmatrix} 1 & 0 \\ 0 & 0 \\ 0 & 0 \end{pmatrix}$, $\begin{pmatrix} 0 & 0 \\ 0 & 1 \\ 0 & 0 \end{pmatrix}$,

or $\begin{pmatrix} 0 & 0 \\ 0 & 0 \\ 1 & 1 \end{pmatrix}$).

Hence $g(F) = -rst$ is rank-one affine on L .

However

$$\int_{(0,1)^2} g(Du) dx = -\frac{1}{4} < 0 = g\left(\int_{(0,1)^2} Du dx\right),$$

violating quasiconvexity.

For $F \in M^{3 \times 2}$ define

$$f_{\varepsilon,k}(F) = g(PF) + \varepsilon(|F|^2 + |F|^4) + k|F - PF|^2,$$

where $P : M^{3 \times 2} \rightarrow L$ is orthogonal projection.

Can check that for each $\varepsilon > 0$ there exists $k(\varepsilon) > 0$ such that $f_\varepsilon = f_{\varepsilon,k(\varepsilon)}$ is rank-one convex, and we still get a contradiction.

So is there a tractable characterization of quasiconvexity? This is the main road-block of the subject.

Theorem 12 (Kristensen 1999)

For $m \geq 3, n \geq 2$ there is no local condition equivalent to quasiconvexity (for example, no condition involving W and any number of its derivatives at an arbitrary matrix F).

Idea of proof. Sverak's W is 'locally quasiconvex', i.e. it coincides with a quasiconvex function in a neighbourhood of any F .

This might lead one to think that no characterization of quasiconvexity is possible. On the other hand Kristensen also proved

Theorem 13 (Kristensen)

For $m \geq 2, n \geq 2$ polyconvexity is not a local condition.

For example, one might contemplate a characterization of the type

W quasiconvex $\Leftrightarrow W$ is the supremum of a family of special quasiconvex functions (including null Lagrangians).

Existence based on polyconvexity

We will show that it is possible to prove the existence of minimizers for mixed boundary value problems if we assume W is polyconvex and satisfies (H1) and appropriate growth conditions. Furthermore the hypotheses are satisfied by various commonly used models of natural rubber and other materials.

Theorem 14

Suppose that W satisfies (H1) and the hypotheses

(H3) $W(F) \geq c_0(|F|^2 + |\operatorname{cof} F|^{3/2}) - c_1$ for all $F \in M^{3 \times 3}$, where $c_0 > 0$,

(H4) W is *polyconvex*, i.e. $W(F) = g(F, \operatorname{cof} F, \det F)$ for all $F \in M^{3 \times 3}$ for some continuous convex g .

Assume that there exists some y in

$$\mathcal{A} = \{y \in W^{1,1}(\Omega; \mathbf{R}^3) : y|_{\partial\Omega_1} = \bar{y}\}$$

with $I(y) < \infty$, where $\mathcal{H}^2(\partial\Omega_1) > 0$ and $\bar{y} : \partial\Omega_1 \rightarrow \mathbf{R}^3$ is measurable. Then there exists a global minimizer y^* of I in \mathcal{A} .

Theorem 14 is a refinement (weakening the growth conditions) of

J.M. Ball, *Convexity conditions and existence theorems in nonlinear elasticity*. Arch. Rat. Mech. Anal., 63:337–403, 1977

(see also J.M. Ball. *Constitutive inequalities and existence theorems in nonlinear elastostatics*. In R.J. Knops, editor, *Nonlinear Analysis and Mechanics, Heriot-Watt Symposium, Vol. 1*. Pitman, 1977.)

due to

S. Müller, T. Qi, and B.S. Yan. *On a new class of elastic deformations not allowing for cavitation*. Ann. Inst. Henri Poincaré, Analyse Nonlinéaire, 11:217243, 1994.

Proof of Theorem 14

To give a reasonably simple proof we will combine (H1), (H3), (H4) into the single hypothesis

$$W(F) = g(F, \operatorname{cof} F, \det F)$$

for some continuous convex function $g : M^{3 \times 3} \times M^{3 \times 3} \times \mathbf{R} \rightarrow \mathbf{R} \cup +\infty$ with $g(F, H, \delta) < \infty$ iff $\delta > 0$ and

$$g(F, H, \delta) \geq c_0(|F|^p + |H|^{p'}) + h(\delta),$$

for all $F \in M^{3 \times 3}$, where $p \geq 2$, $\frac{1}{p} + \frac{1}{p'} = 1$, $c_0 > 0$ and $h : \mathbf{R} \rightarrow [0, \infty]$ is continuous with $h(\delta) < \infty$ iff $\delta > 0$ and $\lim_{\delta \rightarrow \infty} \frac{h(\delta)}{\delta} = \infty$.

Let $l = \inf_{y \in \mathcal{A}} I(y)$ and let $y^{(j)}$ be a minimizing sequence for I in \mathcal{A} , so that

$$\lim_{j \rightarrow \infty} I(y^{(j)}) = l.$$

Then since by assumption $l < \infty$ we may assume that

$$\begin{aligned} l + 1 &\geq I(y^{(j)}) \\ &\geq \int_{\Omega} \left(c_0 [|Dy^{(j)}|^p + |\operatorname{cof} Dy^{(j)}|^{p'}] \right. \\ &\quad \left. + h(\det Dy^{(j)}) \right) dx \end{aligned}$$

for all j .

Lemma 1

There exists a constant $d > 0$ such that

$$\int_{\Omega} |z|^p dx \leq d \left(\int_{\Omega} |Dz|^p dx + \left| \int_{\partial\Omega_1} z dA \right|^p \right)$$

for all $z \in W^{1,p}(\Omega; \mathbf{R}^3)$.

Proof.

Suppose not. Then there exists $z^{(j)}$ such that

$$1 = \int_{\Omega} |z^{(j)}|^p dx \geq j \left(\int_{\Omega} |Dz^{(j)}|^p dx + \left| \int_{\partial\Omega_1} z^{(j)} dA \right|^p \right)$$

for all j .

Thus $z^{(j)}$ is bounded in $W^{1,p}$ and so there is a subsequence $z^{(j_k)} \rightharpoonup z$ in $W^{1,p}$. Since Ω is Lipschitz we have by the embedding and trace theorems that

$$z^{(j_k)} \rightarrow z \text{ strongly in } L^p, \quad z^{(j_k)} \rightharpoonup z \text{ in } L^1(\partial\Omega).$$

In particular $\int_{\Omega} |z|^p dx = 1$.

But since $|\cdot|^p$ is convex we have that

$$\int_{\Omega} |Dz|^p dx \leq \liminf_{k \rightarrow \infty} \int_{\Omega} |Dz^{(j_k)}|^p dx = 0.$$

Hence $Dz = 0$ in Ω , and since Ω is connected it follows that $z = \text{constant}$ a.e. in Ω . But also we have that $\int_{\partial\Omega_1} z dA = 0$, and since $\mathcal{H}^2(\partial\Omega_1) > 0$ it follows that $z = 0$, contradicting $\int_{\Omega} |z|^p dx = 1$.

By Lemma 1 the minimizing sequence $y^{(j)}$ is bounded in $W^{1,p}$ and so we may assume that $y^{(j)} \rightharpoonup y^*$ in $W^{1,p}$ for some y^* .

But also we have that $\text{cof } Dy^{(j)}$ is bounded in $L^{p'}$ and that $\int_{\Omega} h(\det Dy^{(j)}) dx$ is bounded. So we may assume that $\text{cof } Dy^{(j)} \rightharpoonup H$ in $L^{p'}$ and that $\det Dy^{(j)} \rightharpoonup \delta$ in L^1 .

By the results on the weak continuity of minors we deduce that $H = \text{cof } Dy^*$ and $\delta = \det Dy^*$.

Let $u^{(j)} = (Dy^{(j)}, \text{cof } Dy^{(j)}, \det Dy^{(j)})$,
 $u = (Dy^*, \text{cof } Dy^*, \det Dy^*)$. Then

$$u^{(j)} \rightharpoonup u \text{ in } L^1(\Omega; \mathbf{R}^{19}).$$

But g is convex, and so using Mazur's theorem as in the proof of Theorem 1,

$$\begin{aligned} I(y^*) &= \int_{\Omega} g(u) \, dx \leq \liminf_{j \rightarrow \infty} \int_{\Omega} g(u^{(j)}) \, dx \\ &= \lim_{j \rightarrow \infty} I(y^{(j)}) = l. \end{aligned}$$

But $y^{(j)}|_{\partial\Omega_1} = \bar{y} \rightarrow y^*|_{\partial\Omega_1}$ in $L^1(\partial\Omega_1; \mathbf{R}^3)$ and so $y^* \in \mathcal{A}$ and y^* is a minimizer.

Incompressible elasticity

Rubber is almost incompressible. Thus very large forces, and a lot of energy, are required to change its volume significantly. Such materials are well modelled by the constrained theory of *incompressible elasticity*, in which the deformation gradient is required to satisfy the pointwise constraint

$$\det F = 1.$$

Existence of minimizers in incompressible elasticity

Theorem 15

Let $U = \{F \in M^{3 \times 3} : \det F = 1\}$. Suppose $W : U \rightarrow [0, \infty)$ is continuous and such that

$$(H3)' \quad W(F) \geq c_0(|F|^2 + |\operatorname{cof} F|^{\frac{3}{2}}) - c_1$$

for all $F \in U$,

(H4)' W is polyconvex, i.e. $W(F) = g(F, \operatorname{cof} F)$

for all $F \in U$ for some continuous convex g .

Assume that there exists some y in

$$\mathcal{A} = \{y \in W^{1,1}(\Omega; \mathbf{R}^3) : \det Dy(x) = 1 \text{ a.e.}, y|_{\partial\Omega_1} = \bar{y}\}$$

with $I(y) < \infty$, where $\mathcal{H}^2(\partial\Omega_1) > 0$ and

$\bar{y} : \partial\Omega_1 \rightarrow \mathbf{R}^3$ is measurable. Then there exists a global minimizer y^* of I in \mathcal{A} .

Proof.

For simplicity suppose that

$W(F) = g(F, \operatorname{cof} F)$ for some continuous convex $g : M^{3 \times 3} \times M^{3 \times 3} \rightarrow \mathbf{R}$, where

$g(F, H) \geq c_0(|F|^p + |H|^q) - c_1$ for all F, H , where $p \geq 2, q \geq p'$ and $c_0 > 0$.

Letting $y^{(j)}$ be a minimizing sequence the only new point is to show that the constraint is satisfied. But since $\det Dy^{(j)} = 1$ we have by the weak continuity properties that for a subsequence $\det Dy^{(j)} \xrightarrow{*} \det Dy$ in L^∞ , so that the weak limit satisfies $\det Dy = 1$.

Models of natural rubber

1. Modelled as an incompressible isotropic material.

Constraint is $\det F = v_1 v_2 v_3 = 1$.

Neo-Hookean material

$$\Phi = \alpha(v_1^2 + v_2^2 + v_3^2 - 3),$$

where $\alpha > 0$ is a constant. This can be derived from a simple statistical mechanics model of long-chain molecules.

Mooney-Rivlin material.

$$\Phi = \alpha(v_1^2 + v_2^2 + v_3^2 - 3) \\ + \beta((v_2v_3)^2 + (v_3v_1)^2 + (v_1v_2)^2 - 3),$$

where $\alpha > 0, \beta > 0$ are constants. Gives a better fit to bi-axial experiments of Rivlin & Saunders.

Ogden materials.

$$\Phi = \sum_{i=1}^N \alpha_i (v_1^{p_i} + v_2^{p_i} + v_3^{p_i} - 3) \\ + \sum_{i=1}^M \beta_i ((v_2v_3)^{q_i} + (v_3v_1)^{q_i} + (v_1v_2)^{q_i} - 3),$$

where $\alpha_i, \beta_i, p_i, q_i$ are constants.

e.g. for a certain vulcanised rubber a good fit is given by $N = 2, M = 1, p_1 = 5.0,$
 $p_2 = 1.3, q_1 = 2, \alpha_1 = 2.4 \times 10^{-3}, \alpha_2 = 4.8,$
 $\beta_1 = 0.05 \text{kg/cm}^2.$ The high power 5 allows a better modelling of the tautening of rubber as the long-chain molecules are highly stretched and the cross-links tend to prevent further stretching.

2. Modelled as compressible isotropic material
Add $h(v_1 v_2 v_3)$ to above Φ , where h is convex,
 $h(\delta) \rightarrow \infty$ as $\delta \rightarrow 0+$, and h has a steep mini-
mum near $\delta = 1$.

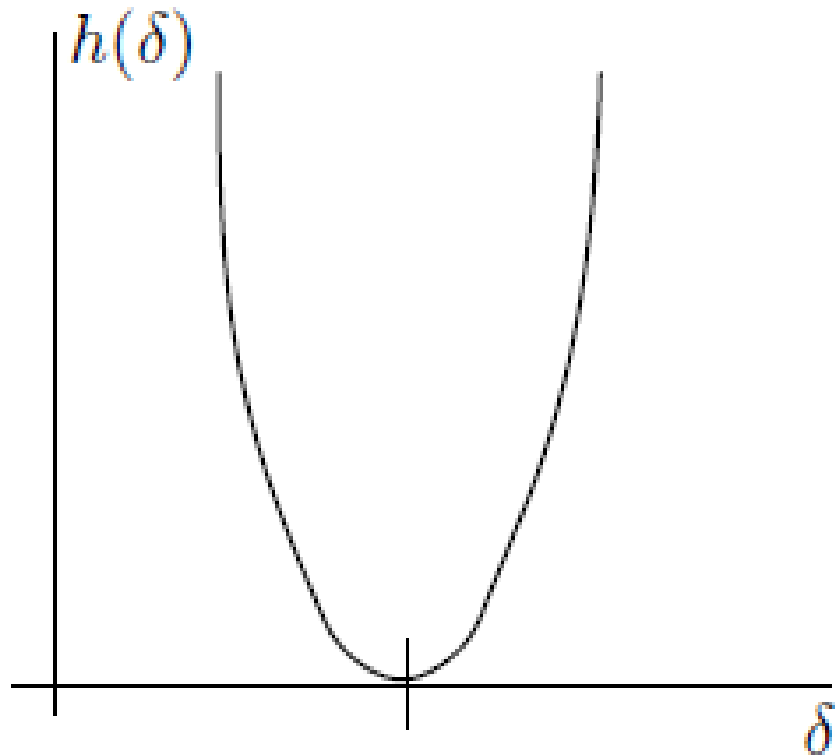

Convexity properties of isotropic functions

Let $\mathbf{R}_+^n = \{x = (x_1, \dots, x_n) \in \mathbf{R}^n : x_i \geq 0\}$.

Theorem 16 (Thompson & Freede)

Let $n \geq 1$ and for $F \in M^{n \times n}$ let

$$W(F) = \Phi(v_1, \dots, v_n),$$

where Φ is a symmetric real-valued function of the singular values v_i of F . Then W is convex on $M^{n \times n}$ iff Φ is convex on \mathbf{R}_+^n and nondecreasing in each v_i .

Proof.

Necessity. If W is convex then clearly Φ is convex. Also for fixed nonnegative

$$v_1, \dots, v_{k-1}, v_{k+1}, \dots, v_n$$

$$g(v) = W(\text{diag}(v_1, \dots, v_{k-1}, |v|, v_{k+1}, \dots, v_n))$$

is convex and even in v . But any convex and even function of $|v|$ is nondecreasing for $v > 0$.

The sufficiency uses von Neumann's inequality
- for the details see Ball (1977).

Lemma 2 (von Neumann)

Let $A, B \in M^{n \times n}$ have singular values

$v_1(A) \geq \dots \geq v_n(A)$, $v_1(B) \geq \dots \geq v_n(B)$

respectively. Then

$$\max_{Q, R \in O(n)} \operatorname{tr}(QARB) = \sum_{i=1}^n v_i(A)v_i(B).$$

Applying Theorem 16 we see that if $p \geq 1$ then

$$\Phi_p(F) = v_1^p + v_2^p + v_3^p$$

is a convex function of F .

Since the singular values of $\text{cof } F$ are v_2v_3, v_3v_1, v_1v_2 it also follows that if $q \geq 1$

$$\Psi_q(F) = (v_2v_3)^q + (v_3v_1)^q + (v_1v_2)^q$$

is a convex function of $\text{cof } F$.

Hence the incompressible Ogden material

$$\Phi = \sum_{i=1}^N \alpha_i (v_1^{p_i} + v_2^{p_i} + v_3^{p_i} - 3) \\ + \sum_{i=1}^M \beta_i ((v_2 v_3)^{q_i} + (v_3 v_1)^{q_i} + (v_1 v_2)^{q_i} - 3),$$

is polyconvex if the $\alpha_i \geq 0, \beta_i \geq 0,$

$p_1 \geq \dots \geq p_N \geq 1, q_1 \geq \dots \geq q_M \geq 1.$

And in the compressible case if we add a convex function $h = h(\det F)$ of $\det F$ then under the same conditions the stored-energy function is polyconvex.

It remains to check the growth condition of Theorems 14, 15, namely

$$W(F) \geq c_0(|F|^2 + |\operatorname{cof} F|^{3/2}) - c_1$$

for all $F \in M^{3 \times 3}$, where $c_0 > 0$.

This holds for the Ogden materials provided $p_1 \geq 2$, $q_1 \geq \frac{3}{2}$ and $\alpha_1 > 0$, $\beta_1 > 0$.

This includes the case of the Mooney-Rivlin material, but *not* the neo-Hookean material. In the incompressible case, Theorem 15 covers the case of the stored-energy function

$$\Phi = \alpha(v_1^p + v_2^p + v_3^p - 3)$$

if $p \geq 3$.

For the neo-Hookean material (incompressible or with $h(\det F)$ added) it is not known if there exists an energy minimizer in \mathcal{A} , but it seems unlikely because of the phenomenon of *cavitation*.

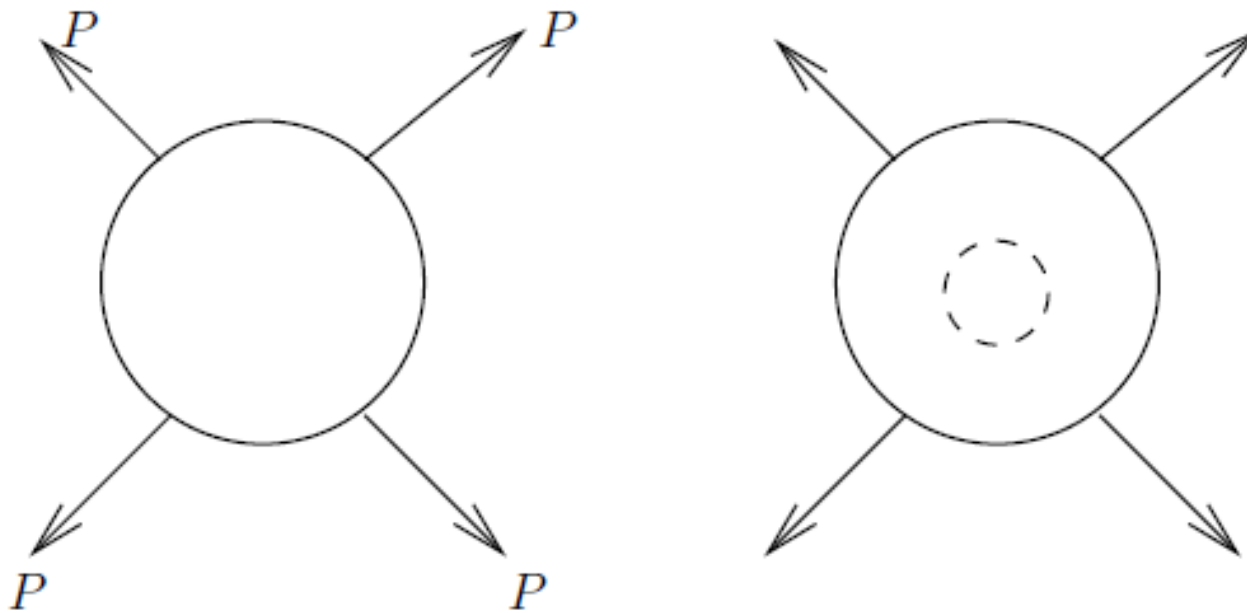

In particular the stored-energy function

$$W(F) = \alpha(|F|^2 - 3) + h(\det F)$$

is not $W^{1,2}$ quasiconvex (same definition but with the test functions $\varphi \in W_0^{1,2}$ instead of $W_0^{1,\infty}$).

To see this consider the radial deformation $y : B(0, 1) \rightarrow \mathbf{R}^3$ given by

$$y(x) = \frac{r(R)}{R}x,$$

where $R = |x|$.

Since $y_i = \frac{r(R)}{R}x_i$ it follows that

$$y_{i,\alpha} = \frac{r(R)}{R}\delta_{i\alpha} + \left(\frac{r' - \frac{r}{R}}{R}\right)\frac{x_i x_\alpha}{R},$$

that is

$$Dy(x) = \frac{r}{R}\mathbf{1} + \left(r' - \frac{r}{R}\right)\frac{x}{R} \otimes \frac{x}{R}.$$

In particular

$$|Dy(x)|^2 = r'^2 + 2\left(\frac{r(R)}{R}\right)^2.$$

Set $F = \lambda \mathbf{1}$ where $\lambda > 0$. Then

$$W(\lambda \mathbf{1}) = 3\alpha(\lambda^2 - 1) + h(\lambda^3).$$

On the other hand, if we choose

$$r^3(R) = R^3 + \lambda^3 - 1,$$

then $y(x) = \lambda x$ for $|x| = 1$ and

$$\det Dy(x) = r' \left(\frac{r}{R} \right)^2 = 1.$$

Then

$$\begin{aligned} & \int_{B(0,1)} [\alpha(|Dy(x)|^2 - 3) + h(\det Dy(x))] dx \\ &= 4\pi \int_0^1 R^2 \left[\alpha \left(\left(\frac{R^3 + \lambda^3 - 1}{R^3} \right)^{-\frac{4}{3}} \right. \right. \\ & \quad \left. \left. + 2 \left(\frac{R^3 + \lambda^3 - 1}{R^3} \right)^{\frac{2}{3}} - 3 \right) + h(1) \right] dR, \end{aligned}$$

which is of order λ^2 for large λ .

Hence

$$\int_{B(0,1)} W(Dy(x)) dx < \int_{B(0,1)} W(\lambda \mathbf{1}) dx$$

for large λ .

Since $W^{1,2}$ quasiconvexity is necessary for weak lower semicontinuity of $I(y)$ in $W^{1,2}$ this suggests that the minimum is not attained. (For a further argument suggesting this see J.M. Ball, *Progress and Puzzles in Nonlinear Elasticity*, Proceedings of course on Poly-, Quasi- and Rank-One Convexity in Applied Mechanics, CISM, Udine, 2010.

However there *is* an existence theory that covers the neo-Hookean and other cases of polyconvex energies with slow growth, due to M. Giaquinta, G. Modica and J. Souček, Arch. Rational Mech. Anal. 106 (1989), no. 2, 97-159

using Cartesian currents. In the previous example this would give as the minimizer $y(x) = \lambda x$, i.e. the function space setting does not allow cavitation. A simpler proof of this result is in S. Müller, *Weak continuity of determinants and nonlinear elasticity*, C. R. Acad. Sci. Paris Ser. I Math. 307 (1988), no. 9, 501-506.

The Euler-Lagrange equations

Suppose that $W \in C^1(M_+^{3 \times 3})$. Can we show that the minimizer y^* in Theorem 14 satisfies the weak form of the Euler-Lagrange equations?

As we have seen the standard form of these are formally obtained by computing

$$\frac{d}{d\tau} I(y + \tau\varphi)|_{\tau=0} = \frac{d}{d\tau} \int_{\Omega} W(Dy + \tau D\varphi) dx|_{t=0} = 0,$$

for smooth φ with $\varphi|_{\partial\Omega_1} = 0$.

This leads to the weak form

$$\int_{\Omega} D_F W(Dy) \cdot D\varphi \, dx = 0$$

for all smooth φ with $\varphi|_{\partial\Omega_1} = 0$.

As we have seen, the problem in deriving this weak form is that $|DW(Dy)|$ can be bigger than $W(Dy)$, and that we do not know if

$$\det Dy(x) \geq \mu > 0 \text{ a.e.}$$

It is an open problem to give hypotheses under which this or the above weak form can be proved.

However, it turns out to be possible to derive other weak forms of the Euler-Lagrange equations by using variations involving compositions of maps.

We consider the following conditions that may be satisfied by W :

$$(C1) \quad |D_F W(F) F^T| \leq K(W(F)+1) \quad \text{for all } F \in M_+^{3 \times 3},$$

where $K > 0$ is a constant, and

$$(C2) \quad |F^T D_F W(F)| \leq K(W(F)+1) \quad \text{for all } F \in M_+^{3 \times 3},$$

where $K > 0$ is a constant.

As usual, $|\cdot|$ denotes the Euclidean norm on $M^{3 \times 3}$, for which the inequalities $|F \cdot G| \leq |F| \cdot |G|$ and $|FG| \leq |F| \cdot |G|$ hold. But of course the conditions are independent of the norm used up to a possible change in the constant K .

Proposition 4

Let W satisfy (C2). Then W satisfies (C1).

Proof

Since W is frame-indifferent the matrix $D_F W(F) F^T$ is symmetric (this is equivalent to the symmetry of the Cauchy stress tensor

$T = (\det F)^{-1} T_R(F) F^T$). To prove this, note that

$$\frac{d}{dt} W(\exp(Kt)F)|_{t=0} = D_F W(F) \cdot (KF) = 0$$

for all skew K . Hence

$$\begin{aligned} |D_F W(F) F^T|^2 &= [D_F W(F) F^T] \cdot [F (D_F W(F))^T] \\ &= [F^T D_F W(F)] \cdot [F^T D_F W(F)]^T \\ &\leq |F^T D_F W(F)|^2, \end{aligned}$$

from which the result follows.

Example

Let

$$W(F) = (F^T F)_{11} + \frac{1}{\det F} .$$

Then W is frame-indifferent and satisfies (C1) but not (C2).

Exercise: check this.

As before let

$$\mathcal{A} = \{y \in W^{1,1}(\Omega; \mathbf{R}^3) : y|_{\partial\Omega_1} = \bar{y}\}.$$

We say that y is a $W^{1,p}$ *local minimizer* of

$$I(y) = \int_{\Omega} W(Dy) dx$$

in \mathcal{A} if $I(y) < \infty$ and

$$I(z) \geq I(y) \text{ for all } z \in \mathcal{A}$$

with $\|z - y\|_{1,p}$ sufficiently small.

Theorem 17

For some $1 \leq p < \infty$ let $y \in \mathcal{A} \cap W^{1,p}(\Omega; \mathbf{R}^3)$ be a $W^{1,p}$ local minimizer of I in \mathcal{A} .

(i) Let W satisfy (C1). Then

$$\int_{\Omega} [D_F W(Dy) Dy^T] \cdot D\varphi(y) dx = 0$$

for all $\varphi \in C^1(\mathbf{R}^3; \mathbf{R}^3)$ such that φ and $D\varphi$ are uniformly bounded and satisfy $\varphi(y)|_{\partial\Omega_1} = 0$ in the sense of trace.

(ii) Let W satisfy (C2). Then

$$\int_{\Omega} [W(Dy)\mathbf{1} - Dy^T D_F W(Dy)] \cdot D\varphi dx = 0$$

for all $\varphi \in C_0^1(\Omega; \mathbf{R}^3)$.

We use the following simple lemma.

Lemma 3

(a) If W satisfies (C1) then there exists $\gamma > 0$ such that if $C \in M_+^{3 \times 3}$ and $|C - \mathbf{1}| < \gamma$ then

$$|D_F W(CF)F^T| \leq 3K(W(F) + 1) \text{ for all } F \in M_+^{3 \times 3}.$$

(b) If W satisfies (C2) then there exists $\gamma > 0$ such that if $C \in M_+^{3 \times 3}$ and $|C - \mathbf{1}| < \gamma$ then

$$|F^T D_F W(FC)| \leq 3K(W(F) + 1) \text{ for all } F \in M_+^{3 \times 3}.$$

Proof of Lemma 3

We prove (a); the proof of (b) is similar. We first show that there exists $\gamma > 0$ such that if $|C - \mathbf{1}| < \gamma$ then

$$W(CF) + 1 \leq \frac{3}{2}(W(F) + 1) \text{ for all } F \in M_+^{3 \times 3}.$$

For $t \in [0, 1]$ let $C(t) = tC + (1 - t)\mathbf{1}$. Choose $\gamma \in (0, \frac{1}{6K})$ sufficiently small so that $|C - \mathbf{1}| < \gamma$ implies that $|C(t)^{-1}| \leq 2$ for all $t \in [0, 1]$.

This is possible since $|\mathbf{1}| = \sqrt{3} < 2$.

For $|C - \mathbf{1}| < \gamma$ we have that

$$\begin{aligned} & W(CF) - W(F) \\ &= \int_0^1 \frac{d}{dt} W(C(t)F) dt \\ &= \int_0^1 D_F W(C(t)F) \cdot [(C - \mathbf{1})F] dt \\ &= \int_0^1 D_F W(C(t)F) (C(t)F)^T \cdot ((C - \mathbf{1})C(t)^{-1}) dt \\ &\leq K \int_0^1 [W(C(t)F) + 1] \cdot |C - \mathbf{1}| \cdot |C(t)^{-1}| dt \\ &\leq 2K\gamma \int_0^1 (W(C(t)F) + 1) dt. \end{aligned}$$

Let $\theta(F) = \sup_{|C-1|<\gamma} W(CF)$. Then

$$\begin{aligned} W(CF) - W(F) &\leq \theta(F) - W(F) \\ &\leq 2K\gamma(\theta(F) + 1) \end{aligned}$$

Hence

$$(\theta(F) + 1)(1 - 2K\gamma) \leq W(F) + 1,$$

from which

$$W(CF) + 1 \leq \frac{3}{2}(W(F) + 1)$$

follows.

Finally, if $|C - \mathbf{1}| < \gamma$ we have from (C1) and the above that

$$\begin{aligned} |D_F W(CF) F^T| &= |D_F W(CF) (CF)^T C^{-T}| \\ &\leq K(W(CF) + 1) |C^{-T}| \\ &\leq 3K(W(F) + 1), \end{aligned}$$

as required.

Proof of Theorem 17

Given φ as in the theorem, define for $|\tau|$ sufficiently small

$$y_\tau(x) := y(x) + \tau\varphi(y(x)).$$

Then

$$Dy_\tau(x) = (1 + \tau D\varphi(y(x)))Dy(x) \text{ a.e. } x \in \Omega.$$

and so $y_\tau \in \mathcal{A}$. Also $\det Dy_\tau(x) > 0$ for a.e. $x \in \Omega$ and $\lim_{\tau \rightarrow 0} \|y_\tau - y\|_{W^{1,p}} = 0$.

Hence $I(y_\tau) \geq I(y)$ for $|\tau|$ sufficiently small.

But

$$\begin{aligned} & \frac{1}{\tau}(I(y_\tau) - I(y)) \\ &= \frac{1}{\tau} \int_{\Omega} \int_0^1 \frac{d}{ds} W((1 + s\tau D\varphi(y(x)))Dy(x)) ds dx \\ &= \int_{\Omega} \int_0^1 DW((1 + s\tau D\varphi(y(x)))Dy(x)) \\ & \quad \cdot [D\varphi(y(x))Dy(x)] ds dx. \end{aligned}$$

Since by Lemma 3 the integrand is bounded by the integrable function

$$3K(W(Dy(x)) + 1) \sup_{z \in \mathbf{R}^3} |D\varphi(z)|,$$

we may pass to the limit $\tau \rightarrow 0$ using dominated convergence to obtain

$$\int_{\Omega} [D_F W(Dy) Dy^T] \cdot D\varphi(y) dx = 0,$$

as required.

(ii) This follows in a similar way to (i) from Lemma 3(b). We just sketch the idea. Let $\varphi \in C_0^1(\Omega; \mathbf{R}^3)$. For sufficiently small $\tau > 0$ the mapping θ_τ defined by

$$\theta_\tau(z) := z + \tau\varphi(z)$$

belongs to $C^1(\Omega; \mathbf{R}^3)$, satisfies $\det D\theta_\tau(z) > 0$, and coincides with the identity on $\partial\Omega$. By the global inverse function theorem θ_τ is a diffeomorphism of Ω to itself.

Thus the ‘inner variation’

$$y_\tau(x) := y(z_\tau), \quad x = z_\tau + \tau\varphi(z_\tau)$$

defines a mapping $y_\tau \in \mathcal{A}$, and

$$Dy_\tau(x) = Dy(z_\tau)[1 + \tau D\varphi(z_\tau)]^{-1} \text{ a.e. } x \in \Omega.$$

Since $y \in W^{1,p}$ it follows easily that

$$\|y_\tau - y\|_{W^{1,p}} \rightarrow 0 \text{ as } \tau \rightarrow 0.$$

Changing variables we obtain

$$I(y_\tau) = \int_{\Omega} W(Dy(z)[\mathbf{1} + \tau D\varphi(z)]^{-1}) \det(\mathbf{1} + \tau D\varphi(z)) dz,$$

from which

$$\int_{\Omega} [W(Dy)\mathbf{1} - Dy^T D_F W(Dy)] \cdot D\varphi dx = 0$$

follows from (C2) and Lemma 3 using dominated convergence.

Interpretations of the weak forms

To interpret Theorem 17 (i), we make the following

Invertibility Hypothesis.

y is a homeomorphism of Ω onto $\Omega' := y(\Omega)$, Ω' is a bounded domain, and the change of variables formula

$$\int_{\Omega} f(y(x)) \det Dy(x) dx = \int_{\Omega'} f(z) dz$$

holds whenever $f : \mathbb{R}^3 \rightarrow \mathbf{R}$ is measurable, provided that one of the integrals exists.

Theorem 18

Assume that the hypotheses of Theorem 17 and the Invertibility Hypothesis hold. Then

$$\int_{\Omega'} \sigma(z) \cdot D\varphi(z) dz = 0$$

for all $\varphi \in C^1(\mathbf{R}^3; \mathbf{R}^3)$ such that $\varphi|_{y(\partial\Omega_1)} = 0$, where the Cauchy stress tensor σ is defined by

$$\sigma(z) := T(y^{-1}(z)), \quad z \in \Omega'$$

and $T(x) = (\det Dy(x))^{-1} D_F W(Dy(x)) Dy(x)^T$.

Proof. Since by assumption $y(\bar{\Omega})$ is bounded, we can assume that φ and $D\varphi$ are uniformly bounded. The result then follows straightforwardly.

Thus Theorem 17 (i) asserts that y satisfies the spatial (Eulerian) form of the equilibrium equations. Theorem 17 (ii), on the other hand, involves the so-called energy-momentum tensor

$$E(F) = W(F)\mathbf{1} - F^T D_F W(F),$$

and is a multi-dimensional version of the Du Bois Reymond or Erdmann equation of the one-dimensional calculus of variations, and is the weak form of the equation

$$\text{Div } E(Dy) = 0.$$

The hypotheses (C1) and (C2) imply that W has polynomial growth.

Proposition 4

Suppose W satisfies (C1) or (C2). Then for some $s > 0$

$$W(F) \leq M(|F|^s + |F^{-1}|^s) \text{ for all } F \in M_+^{3 \times 3}.$$

Proof

Let $V \in M^{3 \times 3}$ be symmetric. For $t \geq 0$

$$\begin{aligned} \left| \frac{d}{dt} W(e^{tV}) \right| &= |(D_F W(e^{tV}) e^{tV}) \cdot V| \\ &= |(e^{tV} D_F W(e^{tV})) \cdot V| \\ &\leq K(W(e^{tV}) + 1)|V|. \end{aligned}$$

From this it follows that

$$W(e^V) + 1 \leq (W(1) + 1)e^{K|V|}.$$

Now set $V = \ln U$, where $U = U^T > 0$, and denote by v_i the eigenvalues of U .

Since

$$|\ln U| = \left(\sum_{i=1}^3 (\ln v_i)^2 \right)^{1/2} \leq \sum_{i=1}^3 |\ln v_i|,$$

it follows that

$$\begin{aligned} e^{K|\ln U|} &\leq (v_1^K + v_1^{-K})(v_2^K + v_2^{-K})(v_3^K + v_3^{-K}) \\ &\leq 3^{-3} \left(\sum_{i=1}^3 v_i^K + \sum_{i=1}^3 v_i^{-K} \right)^3 \\ &\leq C \left(\sum_{i=1}^3 v_i^{3K} + \sum_{i=1}^3 v_i^{-3K} \right) \\ &\leq C_1 [|U|^{3K} + |U^{-1}|^{3K}], \end{aligned}$$

where $C > 0$, $C_1 > 0$ are constants.

We thus obtain

$$W(U) \leq M(|U|^{3K} + |U^{-1}|^{3K}),$$

where $M = C_1(W(1) + 1)$. The result now follows from the polar decomposition $F = RU$ of an arbitrary $F \in M_+^{3 \times 3}$, where $R \in \text{SO}(3)$, $U = U^T > 0$.

If $W = \Phi(v_1, v_2, v_3)$ is isotropic then both (C1) and (C2) are equivalent (Exercise) to the condition that

$$|(v_1 \Phi_{,1}, v_2 \Phi_{,2}, v_3 \Phi_{,3})| \leq K(\Phi(v_1, v_2, v_3) + 1)$$

for all $v_i > 0$ and some $K > 0$, where $\Phi_{,i} = \partial\Phi/\partial v_i$.

Now for $p \geq 0, q \geq 0$

$$\sum_{i=1}^3 \left| v_i \frac{\partial}{\partial v_i} (v_1^p + v_2^p + v_3^p) \right| = p(v_1^p + v_2^p + v_3^p),$$

$$\begin{aligned} \sum_{i=1}^3 \left| v_i \frac{\partial}{\partial v_i} ((v_2 v_3)^q + (v_3 v_1)^q + (v_1 v_2)^q) \right| \\ = 2q((v_2 v_3)^q + (v_3 v_1)^q + (v_1 v_2)^q) \end{aligned}$$

And

$$\sum_{i=1}^3 \left| v_i \frac{\partial}{\partial v_i} h(v_1 v_2 v_3) \right| = 3v_1 v_2 v_3 |h'(v_1 v_2 v_3)|$$

Hence both (C1) and (C2) hold for compressible Ogden materials if $p_i \geq 0$, $q_i \geq 0$, $\alpha_i \geq 0$, $\beta_i \geq 0$, and $h \geq 0$,

$$|\delta h'(\delta)| \leq K_1(h(\delta) + 1)$$

for all $\delta > 0$.

Exercise.

Work out a corresponding treatment of weak forms of the Euler-Lagrange equation in the incompressible case.

Existence of minimizers with body and surface forces

Mixed displacement-traction problems.

Suppose that $\partial\Omega = \partial\Omega_1 \cup \partial\Omega_2$, where $\partial\Omega_1 \cap \partial\Omega_2 = \emptyset$. Consider the ‘dead load’ boundary conditions:

$$\begin{aligned}y|_{\partial\Omega_1} &= \bar{y} \\ t_R|_{\partial\Omega_2} &= \bar{t}_R,\end{aligned}$$

where $t_R(x) = D_F W(Dy(x))N(x)$ is the Piola-Kirchhoff stress vector, $N(x)$ is the unit outward normal to $\partial\Omega$ and $\bar{t}_R \in L^1(\partial\Omega_2; \mathbf{R}^3)$.

Suppose the body force b is *conservative*, so that

$$b(y) = -\text{grad}_y \Psi(y),$$

where $\Psi = \Psi(y)$ is a real-valued potential. The most important example is gravity, for which $b = -\rho_R e_3$, where $e_3 = (0, 0, 1)$, where the density in the reference configuration $\rho_R > 0$ is constant. In this case we can take $\Psi(y) = -gy_3$.

Consider the functional

$$I(y) = \int_{\Omega} [W(Dy) + \Psi(y)] dx - \int_{\partial\Omega_2} \bar{t}_R \cdot y dA.$$

Then formally a local minimizer y satisfies

$$\int_{\Omega} [D_F W(Dy) \cdot D\varphi - b(y) \cdot \varphi] dx - \int_{\partial\Omega_2} \bar{t}_R \cdot \varphi dA = 0$$

for all smooth φ with $\varphi|_{\partial\Omega_1} = 0$, and thus

$$\operatorname{Div} D_F W(Dy) + b = 0 \text{ in } \Omega,$$

$$t_R|_{\partial\Omega_2} = \bar{t}_R.$$

Theorem 19

Suppose that W satisfies (H1) and

(H3) $W(F) \geq c_0(|F|^2 + |\operatorname{cof} F|^{3/2}) - c_1$ for all $F \in M^{3 \times 3}$, where $c_0 > 0$,

(H4) W is *polyconvex*, i.e. $W(F) = g(F, \operatorname{cof} F, \det F)$ for all $F \in M^{3 \times 3}$ for some continuous convex g . Assume further that ψ is continuous and such that

$$\psi(y) \geq -d_0|y|^s - d_1$$

for constants $d_0 > 0, d_1 > 0, 1 \leq s < 2$, and that $\bar{t}_R \in L^2(\partial\Omega_2; \mathbf{R}^3)$.

Assume that there exists some y in

$$\mathcal{A} = \{y \in W^{1,1}(\Omega; \mathbf{R}^3) : y|_{\partial\Omega_1} = \bar{y}\}$$

with $I(y) < \infty$, where $\mathcal{H}^2(\partial\Omega_1) > 0$ and $\bar{y} : \partial\Omega_1 \rightarrow \mathbf{R}^3$ is measurable. Then there exists a global minimizer y^* of I in \mathcal{A} .

Sketch of proof.

We need to get a bound on a minimizing sequence $y^{(j)}$. By the trace theorem there is a constant $c_2 > 0$ such that

$$\int_{\Omega} [|Dy|^2 + |y|^2] dx \geq d_0 \int_{\partial\Omega_2} |y|^2 dA$$

for all $y \in W^{1,2}$.

Using Lemma 1 and the boundary condition on $\partial\Omega_1$, we thus have for any $y \in \mathcal{A}$,

$$\begin{aligned}
 I(y) \geq & \frac{c_0}{2} \int_{\Omega} |Dy|^2 dx + c_0 \int_{\Omega} |\operatorname{cof} Dy|^{\frac{3}{2}} dx \\
 & + m \int_{\Omega} |y|^2 dx - d_0 \int_{\Omega} |y|^s dx \\
 & - \frac{1}{2} \int_{\partial\Omega_2} [\varepsilon^{-1} |\bar{t}_R|^2 + \varepsilon |y|^2] dA + \text{const.}
 \end{aligned}$$

Thus choosing a small ε

$$I(y) \geq a_0 \int_{\Omega} [|Dy|^2 + |y|^2 + |\operatorname{cof} Dy|^{\frac{3}{2}}] dx - a_1$$

for all $y \in \mathcal{A}$ and constants $a_0 > 0, a_1$, giving the necessary bound on $y^{(j)}$.

Pure traction problems.

Suppose $\partial\Omega_1 = \emptyset$ and that $b = b_0$ is constant. Then choosing $\varphi = \text{const.}$ we find that a necessary condition for a local minimum is that

$$\int_{\Omega} b_0 dx + \int_{\partial\Omega_2} \bar{t}_R dA = 0,$$

saying that the total applied force on the body is zero.

If this condition holds then I is invariant to the addition of constants, and it is convenient to remove this indeterminacy by minimizing I subject to the constraint

$$\int_{\Omega} y dx = 0.$$

We then get the existence of a minimizer under the same hypotheses as Theorem 19, but using the Poincaré inequality

$$\int_{\Omega} |y|^2 dx \leq C \left(\int_{\Omega} |Dy|^2 dx + \left(\int_{\Omega} y dx \right)^2 \right).$$

It is also possible to treat mixed displacement pressure boundary conditions (see Ball 1977), which are conservative.

Invertibility

Recall the *Global Inverse Function Theorem*, that if $\Omega \subset \mathbf{R}^n$ is a bounded domain with Lipschitz boundary $\partial\Omega$ and if $y \in C^1(\bar{\Omega}; \mathbf{R}^n)$ with

$$\det Dy(x) > 0 \text{ for all } x \in \bar{\Omega}$$

and $y|_{\partial\Omega}$ one-to-one, then y is invertible on $\bar{\Omega}$.

Can we prove a similar theorem for mappings in a Sobolev space?

Before discussing this question let us note an amusing example showing that failure of y to be C^1 at just two points of the boundary can invalidate the theorem.

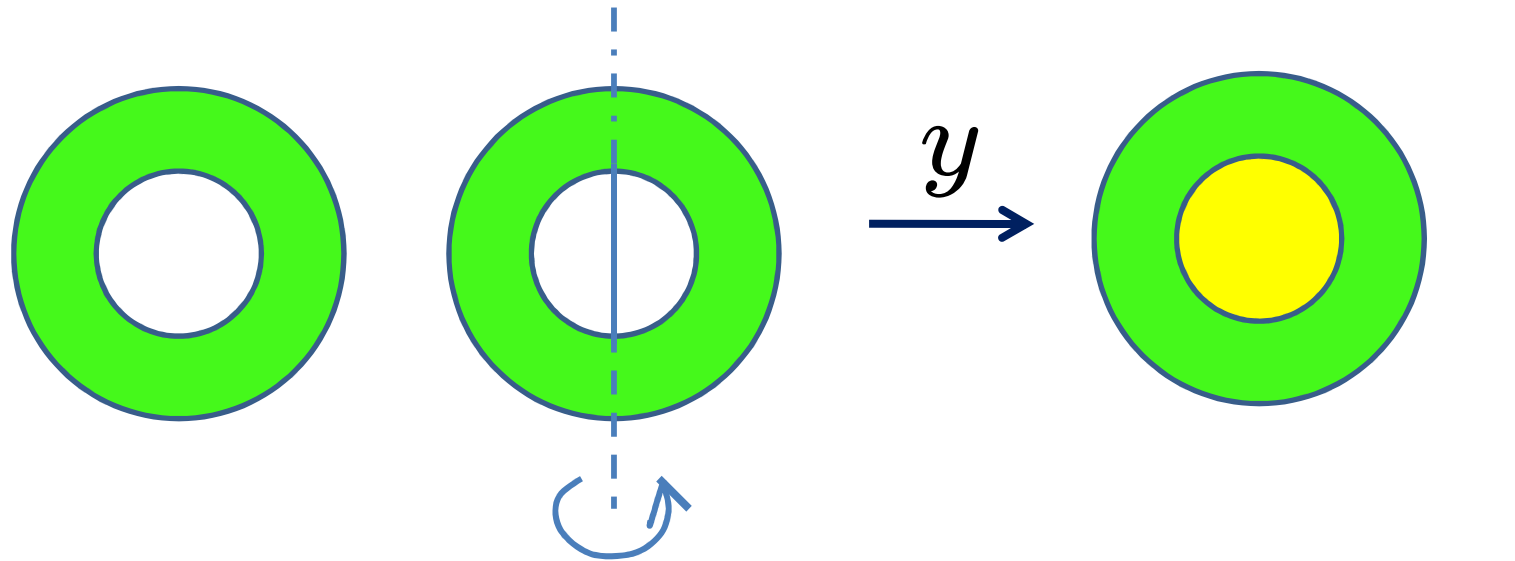

Rubber sheet
stuck to rigid
wires

Inner wire twisted
through π about
vertical axis

Yellow region
double covered

A. Weinstein, *A global invertibility theorem for manifolds with boundary*, Proc. Royal Soc. Edinburgh, 99 (1985) 283–284.

shows that a local homeomorphism from a compact, connected manifold with boundary to a simply connected manifold without boundary is invertible if it is one-to-one on each component of the boundary.

Results for $y \in W^{1,p}$, $p > n$,
(so that y is continuous).

J.M. Ball, Global invertibility of Sobolev functions and the interpenetration of matter, Proc. Royal Soc. Edinburgh 90a(1981)315-328.

Theorem 20

Let $\Omega \subset \mathbf{R}^n$ be a bounded domain with Lipschitz boundary. Let $\bar{y} : \bar{\Omega} \rightarrow \mathbf{R}^n$ be continuous in $\bar{\Omega}$ and one-to-one in Ω . Let $p > n$ and let $y \in W^{1,p}(\Omega; \mathbf{R}^n)$ satisfy $y|_{\partial\Omega} = \bar{y}|_{\partial\Omega}$, $\det Dy(x) > 0$ a.e. in Ω . Then

(i) $y(\bar{\Omega}) = \bar{y}(\bar{\Omega})$,

(ii) y maps measurable sets in $\bar{\Omega}$ to measurable sets in $\bar{y}(\bar{\Omega})$, and the change of variables formula

$$\int_A f(y(x)) \det Dy(x) dx = \int_{\bar{y}(A)} f(v) dv$$

holds for any measurable $A \subset \bar{\Omega}$ and any measurable $f : \mathbf{R}^n \rightarrow \mathbf{R}$, provided one of the integrals exist,

(iii) y is one-to-one a.e., i.e. the set

$$\mathcal{S} = \{v \in \bar{y}(\bar{\Omega}) : y^{-1}(v) \text{ contains more than one element}\}$$

has measure zero,

(iv) if $v \in \bar{y}(\Omega)$ then $y^{-1}(v)$ is a continuum contained in Ω , while if $v \in \partial\bar{y}(\Omega)$ then each connected component of $y^{-1}(v)$ intersects $\partial\Omega$.

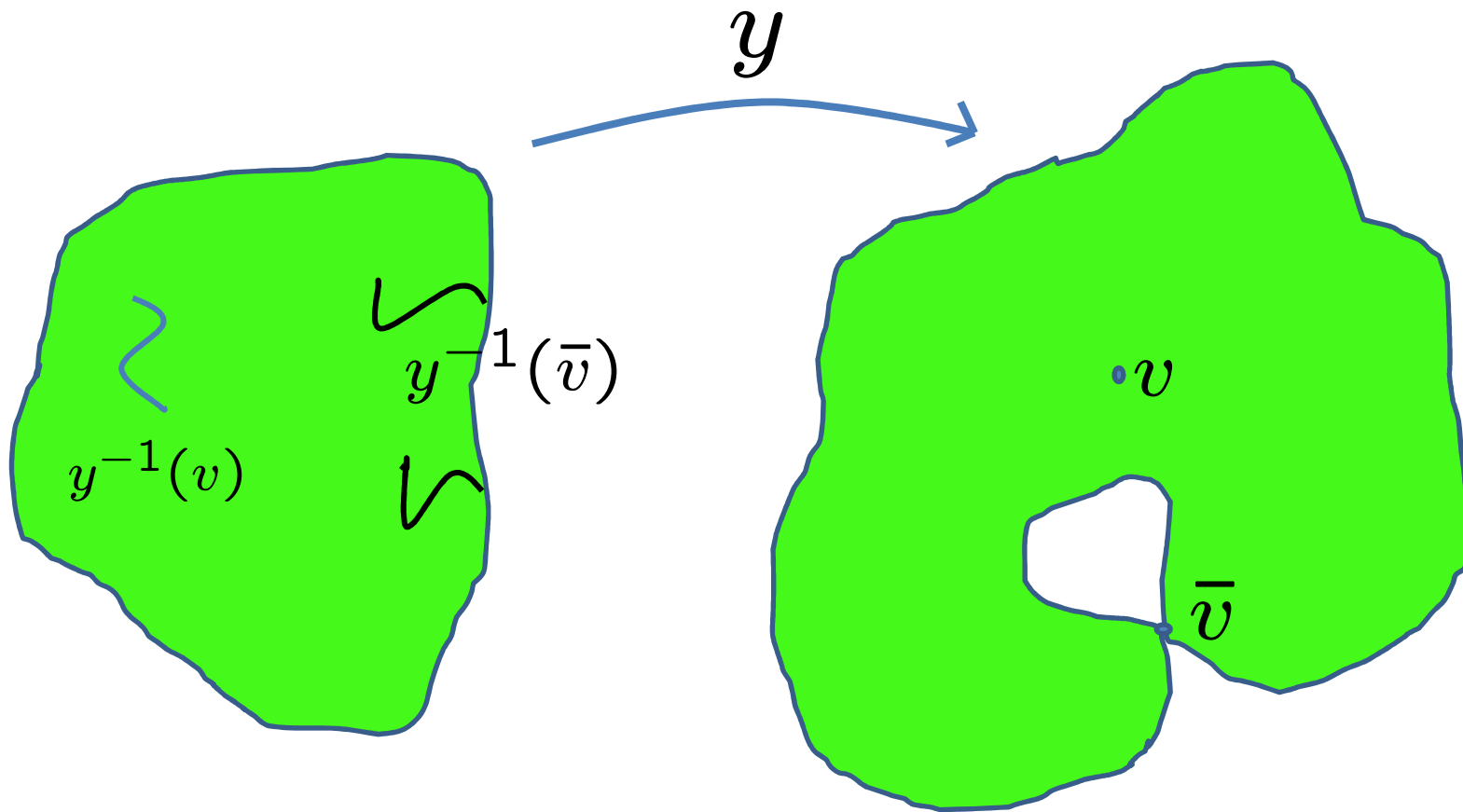

Note that $\bar{y}(\Omega)$ is open by invariance of domain. Proof of theorem uses degree theory and change of variables formula of Marcus and Mizel. Examples with complicated inverse images $y^{-1}(v)$ can be constructed.

Theorem 21

Let the hypotheses of Theorem 20 hold, let $\bar{y}(\Omega)$ satisfy the cone condition, and suppose that for some $q > n$

$$\int_{\Omega} |(Dy(x))^{-1}|^q \det Dy(x) dx < \infty.$$

Then y is a homeomorphism of Ω onto $\bar{y}(\Omega)$, and the inverse function $x(y)$ belongs to $W^{1,q}(\bar{y}(\Omega); \mathbf{R}^n)$. The matrix of weak derivatives $x(\cdot)$ is given by

$$Dx(v) = Dy(x(v))^{-1} \text{ a.e. in } \bar{y}(\Omega).$$

If further $\bar{y}(\Omega)$ is Lipschitz then y is a homeomorphism of $\bar{\Omega}$ onto $\bar{y}(\bar{\Omega})$.

Note that formally we have

$$\begin{aligned} \int_{\Omega} |(Dy(x))^{-1}|^q \det Dy(x) dx \\ = \int_{\bar{y}(\Omega)} |Dx(v)|^q dv. \end{aligned}$$

Idea of proof.

Get the inverse as the limit of a sequence of mollified mappings. Suppose $x(\cdot)$ is the inverse of y . Let ρ_ε be a mollifier, i.e. $\rho_\varepsilon \geq 0$, $\text{supp } \rho_\varepsilon \subset\subset \bar{B}(0, \varepsilon)$, $\int_{\mathbf{R}^n} \rho_\varepsilon(v) dv = 1$, and define

$$x_\varepsilon(v) = \int_{\bar{y}(\Omega)} \rho_\varepsilon(v - u) x(u) du.$$

Changing variables we have

$$x_\varepsilon(v) = \int_{\Omega} \rho_\varepsilon(v - y(z)) z \det Dy(z) dz.$$

In this way the mollified inverse is expressible directly in terms of y , and one can show that for any smooth domain $D \subset\subset \bar{y}(\Omega)$ we have

$$\int_D |Dx_\varepsilon(v)|^q dv \leq M < \infty,$$

where M is independent of sufficiently small ε . Then we can extract a weakly convergent subsequence in $W^{1,p}(D; \mathbf{R}^n)$ for every D , giving a candidate inverse.

For the pure displacement boundary-value problem with boundary condition

$$y|_{\partial\Omega} = \bar{y}|_{\partial\Omega}$$

for which the existence of minimizers was proved in Theorem 14, we get that any minimizer is a homeomorphism provided we strengthen (H3) by assuming that

$$W(F) \geq c_0(|F|^p + |\operatorname{cof} F|^q + (\det F)^{-s}) - c_1,$$

where $p > 3$, $q > 3$, $s > \frac{2q}{q-3}$, and that \bar{y} satisfies the hypotheses of Theorem 21.

With this assumption we have that for any $y \in \mathcal{A}$ with $I(y) < \infty$,

$$\begin{aligned} & \int_{\Omega} |Dy(x)^{-1}|^{\sigma} \det Dy(x) \, dx \\ &= \int_{\Omega} |\operatorname{cof} Dy(x)|^{\sigma} (\det Dy(x))^{1-\sigma} \, dx \\ &\leq c \int_{\Omega} (|\operatorname{cof} Dy|^q + (\det Dy)^{(1-\sigma)(\frac{q}{\sigma})'}) \, dx \\ &< \infty, \end{aligned}$$

where $\sigma = \frac{q(1+s)}{q+s} > 3$, since $(1-\sigma)\left(\frac{q}{\sigma}\right)' = -s$.

An interesting approach to the problem of invertibility (i.e. non-interpenetration of matter) in mixed boundary-value problems is given in P.G. Ciarlet and J. Nečas, *Unilateral problems in nonlinear three-dimensional elasticity*, Arch. Rational Mech. Anal., 87:(1985) 319–338. They proposed minimizing

$$I(y) = \int_{\Omega} W(Dy) dx$$

subject to the boundary condition $y|_{\partial\Omega_1} = \bar{y}$ and the global constraint

$$\int_{\Omega} \det Dy(x) dx \leq \text{volume}(y(\Omega)),$$

If $y \in W^{1,p}(\Omega; \mathbf{R}^3)$ with $p > 3$ then a result of Marcus & Mizel says that

$$\int_{\Omega} \det Dy(x) dx = \int_{y(\Omega)} \text{card } y^{-1}(v) dv.$$

so that the constraint implies that y is one-to-one almost everywhere.

They showed that IF the minimizer y^* is sufficiently smooth then this constraint corresponds to smooth self-contact.

They then proved the existence of minimizers satisfying the constraint for mixed boundary conditions under the growth condition

$$W(F) \geq c_0(|F|^p + |\operatorname{cof} F|^q + (\det F)^{-s}) - c_1,$$

with $p > 3, q \geq \frac{p}{p-1}, s > 0$. (The point is to show that the constraint is weakly closed.)

Results in the space

$$\mathcal{A}_{p,q}^+(\Omega) = \{y : \Omega \rightarrow \mathbf{R}^n; Dy \in L^p(\Omega; M^{n \times n}), \\ \text{cof } Dy \in L^q(\Omega; M^{n \times n}), \det Dy(x) > 0 \text{ a.e. in } \Omega\},$$

following V. Šverák, *Regularity properties of deformations with finite energy*, Arch. Rat. Mech. Anal. 100(1988)105-127.

For the results we are interested in Šverák assumes $p > n - 1, q \geq \frac{p}{p-1}$, but Qi, Müller, Yan show his results go through with $p > n - 1, q \geq \frac{n}{n-1}$, which we assume. Notice that then, since $(\det F)\mathbf{1} = F(\text{cof } F)^T$, we have, taking determinants, that $|\det F|^{n-1} \leq |\det \text{cof } F| \leq |\text{cof } F|^n$, so that $\det Dy \in L^1(\Omega)$.

In fact, if $Dy \in L^{n-1}$, $\text{cof } Dy \in L^{\frac{n}{n-1}}$ then $\det Dy$ belongs to the Hardy space $\mathcal{H}^1(\Omega)$ (Iwaniec & Onninen 2002).

If $y \in \mathcal{A}_{p,q}^+(\Omega)$ with $p > n - 1$, $q \geq \frac{n}{n-1}$ then it is possible to define for every $a \in \Omega$ a set-valued image $F(a, y)$, and thus the image $F(A)$ of a subset A of Ω by

$$F(A) = \cup_{a \in A} F(a, y).$$

Furthermore

Theorem 22

Assume $p \leq n$.

(i) y has a representative \tilde{y} which is continuous outside a singular set \mathcal{S} of Hausdorff dimension $n - p$.

(ii) $\mathcal{H}^{n-1}(F(a)) = 0$ for all $a \in \Omega$.

(iii) For each measurable $A \subset \Omega$, $F(A)$ is measurable and

$$\mathcal{L}^n(F(A)) \leq \int_A \det Dy(x) dx.$$

In particular $\mathcal{L}^n(F(\mathcal{S})) = 0$.

We suppose that Ω is C^∞ and for simplicity that \bar{y} is a diffeomorphism of some open neighbourhood Ω_0 of $\bar{\Omega}$ onto $\bar{y}(\Omega_0)$. Now suppose that $y \in \mathcal{A}_{p,q}^+(\Omega)$ with $y|_{\partial\Omega} = \bar{y}|_{\partial\Omega}$.

Given $v \in \bar{y}(\bar{\Omega})$, let

$$G(v) = \{x \in \bar{\Omega} : v \in F(x)\}.$$

Thus $G(v)$ consists of all inverse images of v .

Theorem 23

(i) For each $v \in \bar{y}(\bar{\Omega})$ the set $G(v)$ is a nonempty continuum in $\bar{\Omega}$.

(ii) For each measurable $A \subset \bar{y}(\bar{\Omega})$ the set $G(A) = \cup_{v \in A} G(v)$ is measurable and

$$\mathcal{L}^n(A) = \int_{G(A)} \det Dy(x) dx.$$

(iii) Let $\mathcal{T} = \{v \in \bar{y}(\bar{\Omega}); \text{diam } G(v) > 0\}$. Then $\mathcal{H}^{n-1}(\mathcal{T}) = 0$.

Thus we can define the inverse function $x(v)$ for all $v \notin \mathcal{T}$, and Šverák proves that $x(\cdot) \in W^{1,1}(\bar{y}(\Omega))$.

Regularity of minimizers

Open Problem: Decide whether or not the global minimizer y^* in Theorem 14 is smooth.

Here smooth means C^∞ in Ω , and C^∞ up to the boundary (except in the neighbourhood of points $x_0 \in \overline{\partial\Omega_1} \cap \overline{\partial\Omega_2}$ where singularities can be expected).

Clearly additional hypotheses on W are needed for this to be true. One might assume, for example, that $W : M_+^{3 \times 3} \rightarrow \mathbf{R}$ is C^∞ , and that W is strictly polyconvex (i.e. that g is strictly convex). Also for regularity up to the boundary we would need to assume both smoothness of the boundary (except perhaps at $\overline{\partial\Omega_1} \cap \overline{\partial\Omega_2}$) and that \bar{y} is smooth. The precise nature of these extra hypotheses is to be determined.

The regularity is unsolved even in the simplest special cases. In fact the only situation in which smoothness of y^* seems to have been proved is for the pure displacement problem with small boundary displacements from a stress-free state. For this case Zhang (1991), following work of Sivaloganathan, gave hypotheses under which the smooth solution to the equilibrium equations delivered by the implicit function theorem was in fact the unique global minimizer y^* of I given by Theorem 14.

An even more ambitious target would be to somehow classify possible singularities in minimizers of I for generic stored-energy functions W . If at the same time one could associate with each such singularity a condition on W that prevented it, one would also, by imposing all such conditions simultaneously, possess a set of hypotheses implying regularity.

It is possible to go a little way in this direction.

Jumps in the deformation gradient

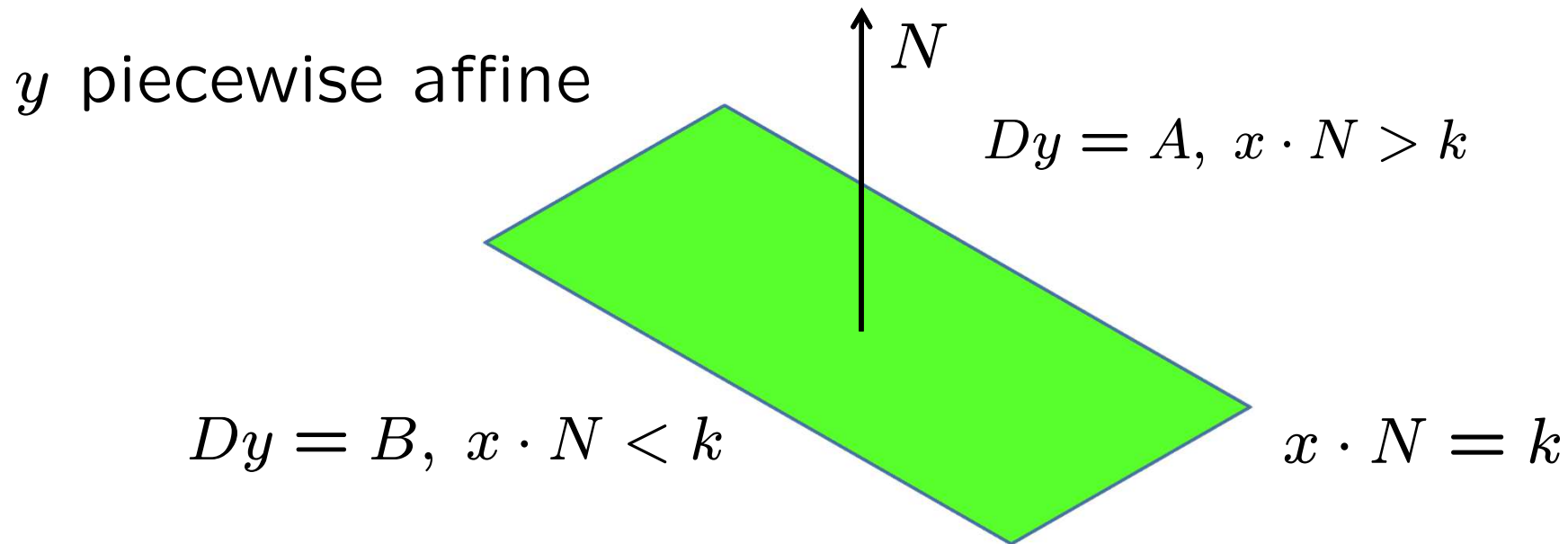

$$A - B = a \otimes N.$$

When can such a y with $A \neq B$ be a weak solution of the equilibrium equations?

Theorem 24

Suppose that $W : M_+^{3 \times 3} \rightarrow \mathbf{R}$ has a local minimizer F_0 . Then every piecewise affine map y as above is C^1 (i.e. $A = B$) iff W is *strictly rank-one convex*, i.e. the map $t \mapsto W(F + ta \otimes N)$ is strictly convex for each $F \in M^{3 \times 3}$ and $a \in \mathbf{R}^3, N \in \mathbf{R}^3$.

J.M. Ball, *Strict convexity, strong ellipticity, and regularity in the calculus of variations*. Proc. Camb. Phil. Soc., 87(1980)501–513.

Sufficiency. Suppose y is a weak solution. Then

$$(DW(A) - DW(B))N = 0.$$

Let $\theta(t) = W(B + ta \otimes N)$. Then $\theta'(1) > \theta'(0)$
and so

$$(DW(A) - DW(B)) \cdot a \otimes N = a \cdot (DW(A) - DW(B))N > 0,$$

a contradiction.

The necessity use a characterization of strictly convex C^1 functions defined on an open convex subset U of \mathbf{R}^n .

Theorem 25

A function $\varphi \in C^1(U)$ is strictly convex iff

(i) there exists some $z \in U$ with

$$\varphi(w) \geq \varphi(z) + \nabla\varphi(z) \cdot (w - z)$$

for $|w - z|$ sufficiently small, and

(ii) $\nabla\varphi$ is one-to-one.

The sufficiency follows by applying this to

$$\varphi(a) = W(B + a \otimes N).$$

the assumption implying that $\nabla\varphi$ is one-to-one.

Proof of Theorem 25 for the case when $U = \mathbf{R}^n$ and $\frac{\varphi(z)}{|z|} \rightarrow \infty$ as $|z| \rightarrow \infty$.

Let $z \in \mathbf{R}^n$. Let $w \in \mathbf{R}^n$ minimize

$$h(v) = \varphi(v) - \nabla\varphi(z) \cdot v.$$

By the growth condition w exists and so

$$\nabla h(w) = \nabla\varphi(w) - \nabla\varphi(z) = 0.$$

Hence $w = z$, the minimum is unique, and so

$$\varphi(v) > \varphi(z) + \nabla\varphi(z) \cdot (v - z)$$

for all $v \neq z$, giving the strict convexity.

Discontinuities in y

An example is cavitation, which we know is prevented (together with other discontinuities) e.g. by

$$W(F) \geq c_0 |F|^n - c_1.$$

Counterexamples to regularity

1. Necas (1977) showed that if $m = n^2$ is sufficiently large, then there exists a strictly convex $f = f(Dy)$ whose corresponding integral

$$I(y) = \int_{B(0,1)} f(Dy) dx$$

has a global minimizer

$$y_{ij}^* = \frac{x_i x_j}{|x|}, \quad x \in B(0, 1)$$

subject to its own (smooth) boundary data on $\partial B(0, 1)$. Here y^* is Lipschitz but not C^1 .

2. Hao, Leonardi & Necas (1996) modified the example to work for $n \geq 5$ with minimizer

$$y_{ij}^* = \frac{x_i x_j}{|x|} - \frac{1}{n} |x| \delta_{ij},$$

and by a more sophisticated method Sverak & Yan (2000) found similar examples which work for $n = 3, m = 5$ and $n = 4, m = 3$.

The cases $m = n = 2$, and $m = n = 3$ remain open.

Quasiconvexity and partial regularity

Theorem (Kristensen & Taheri 2001, following Evans 1986)

Let f be smooth and satisfy for some $p > 2$ the **strong quasiconvexity condition**

$$\int_{\Omega} [f(A + D\phi) - f(A)] dx \geq \gamma \int_{\Omega} [|D\phi|^2 + |D\phi|^p] dx$$

for all $A \in M^{m \times n}$ and all $\phi \in C_0^\infty(\Omega; \mathbf{R}^m)$, together with the growth condition

$$c_0|A|^p - c_1 \leq f(A) \leq d_0|A|^p - d_1.$$

Then any local minimizer y^* of I in $W^{1,p}$ is smooth outside a closed subset $E \subset \Omega$ with $\text{meas } E = 0$.

Remarkable counterexamples of Muller & Sverak (2001) show that this result is false if we assume only that y^* satisfies the weak form of the Euler-Lagrange equation (rather than be a local minimizer).

In view of the above and other counterexamples for elliptic systems, if minimizers are smooth it must be for special reasons applying to elasticity. Plausible such reasons are:

- (a) the integrand depends only on Dy (and perhaps x), and not y
- (b) the dimensions $m = n = 3$ are low,
- (c) the frame-indifference of W .
- (d) invertibility of y .

2D incompressible example.

Minimize

$$I(y) = \int_B |Dy|^2 dx,$$

where $B = B(0, 1)$ is the unit disc in \mathbf{R}^2 , and $y : B \rightarrow \mathbf{R}^2$, in the set of admissible mappings

$$\mathcal{A} = \{y \in W^{1,2}(B; \mathbf{R}^2) : \det Dy = 1 \text{ a.e.}, y|_{\partial B} = \bar{y}\},$$

where in polar coordinates $\bar{y} : (r, \theta) \mapsto (\frac{1}{\sqrt{2}}r, 2\theta)$.

Then there exists a global minimizer y^* of I in \mathcal{A} . (Note that \mathcal{A} is nonempty since $\bar{y} \in \mathcal{A}$.)

But since by degree theory there are no C^1 maps y satisfying the boundary condition, it is immediate that y^* is not C^1 .

Solid phase transformations

Displacive phase transformations are characterized by a change of shape in the crystal lattice at a critical temperature.

e.g. cubic \rightarrow tetragonal

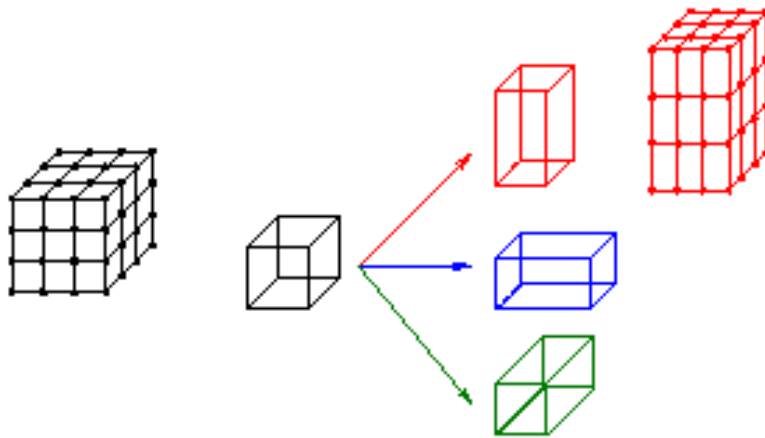

Energy minimization problem for single crystal

Minimize $I_\theta(y) = \int_{\Omega} \psi(Dy(x), \theta) dx$

subject to suitable boundary conditions, for example

$$y|_{\partial\Omega_1} = \bar{y}.$$

$\theta =$ temperature,

$\psi = \psi(F, \theta) =$ free-energy density of crystal,
defined for $F \in M_+^{3 \times 3}$.

Frame-indifference requires

$$\psi(RF, \theta) = \psi(F, \theta) \quad \text{for all } R \in SO(3).$$

If the material has cubic symmetry then also

$$\psi(FQ, \theta) = \psi(F, \theta) \quad \text{for all } Q \in P^{24},$$

where P^{24} is the group of rotations of a cube.

Energy-well structure

$$K(\theta) = \{F \in M_+^{3 \times 3} : F \text{ minimizes } \psi(\cdot, \theta)\}$$

Assume

$$K(\theta) = \begin{cases} \alpha(\theta)SO(3) & \theta > \theta_c \\ SO(3) \cup \bigcup_{i=1}^N SO(3)U_i(\theta_c) & \theta = \theta_c \\ \bigcup_{i=1}^N SO(3)U_i(\theta) & \theta < \theta_c, \end{cases}$$

$$\alpha(\theta_c) = 1$$

austenite

martensite

Assuming the austenite has cubic symmetry, and given the transformation strain U_1 say, the N variants U_i are the distinct matrices QU_1Q^T , where $Q \in P^{24}$.

Cubic to tetragonal (e.g. Ni₆₅Al₃₅)

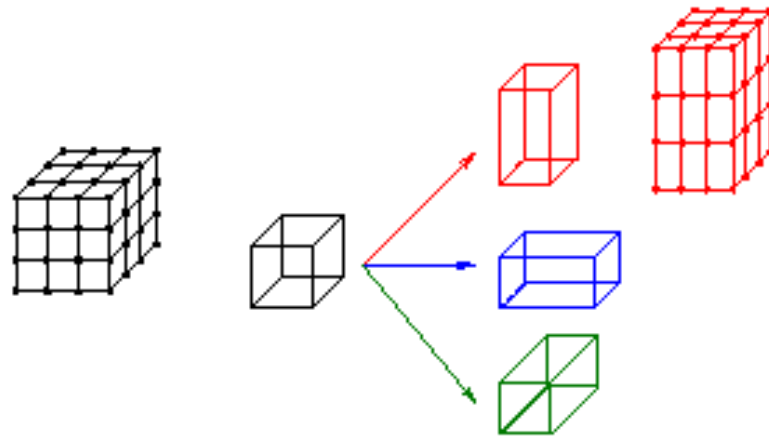

$$N = 3$$

$$U_1 = \text{diag} (\eta_2, \eta_1, \eta_1)$$

$$U_2 = \text{diag} (\eta_1, \eta_2, \eta_1)$$

$$U_3 = \text{diag} (\eta_1, \eta_1, \eta_2)$$

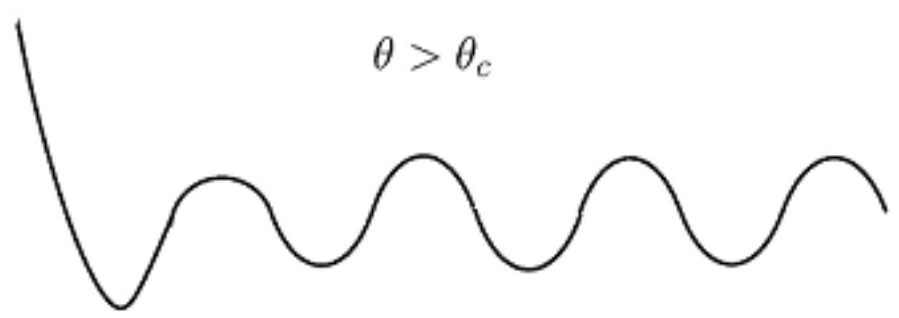

**Exchange of
stability**

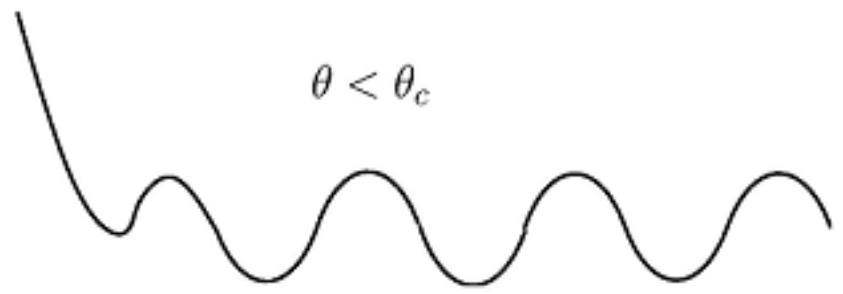
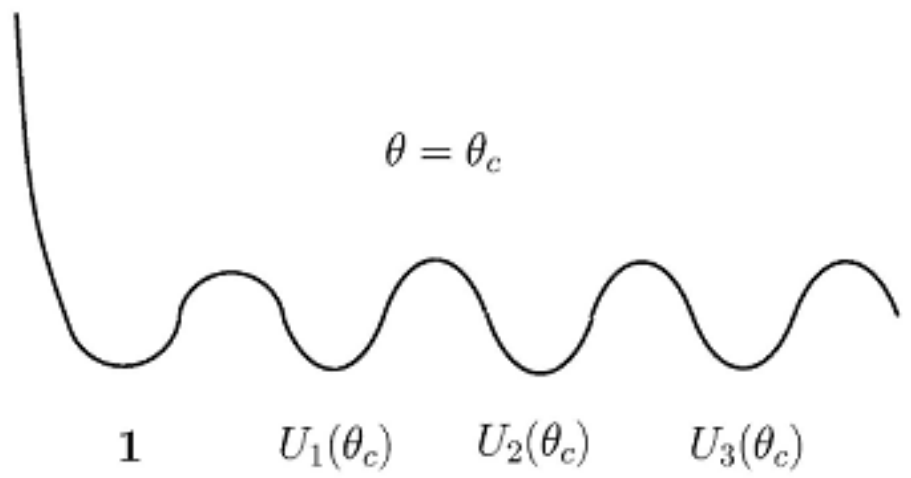

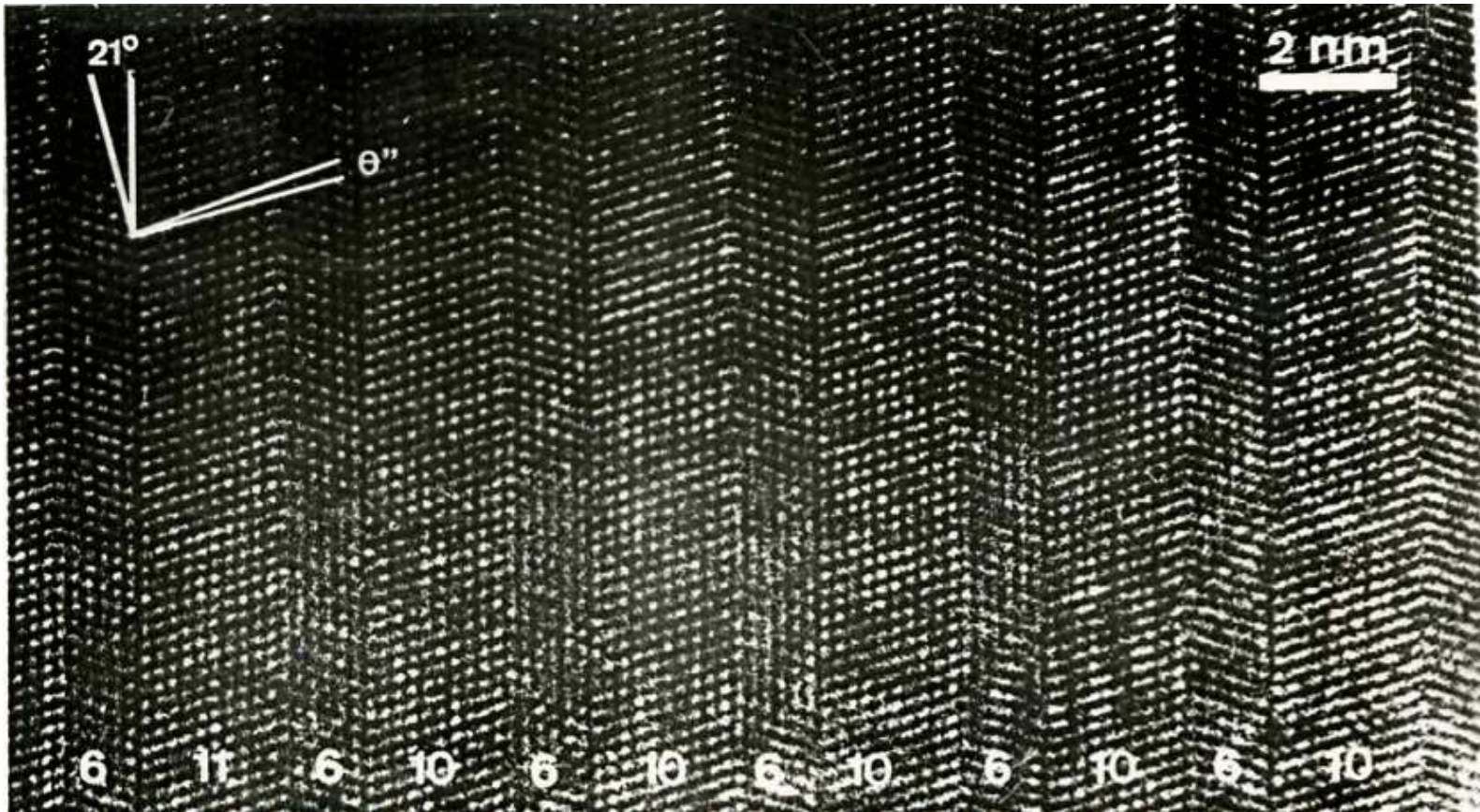

Atomistically sharp interfaces for cubic to tetragonal transformation in NiMn

Baele, van Tenderloo, Amelinckx

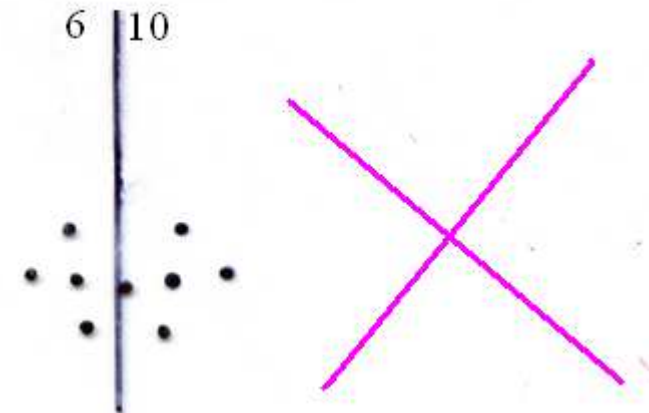

Macrotwins in Ni₆₅Al₃₅ involving two tetragonal variants (Boullay/Schryvers)

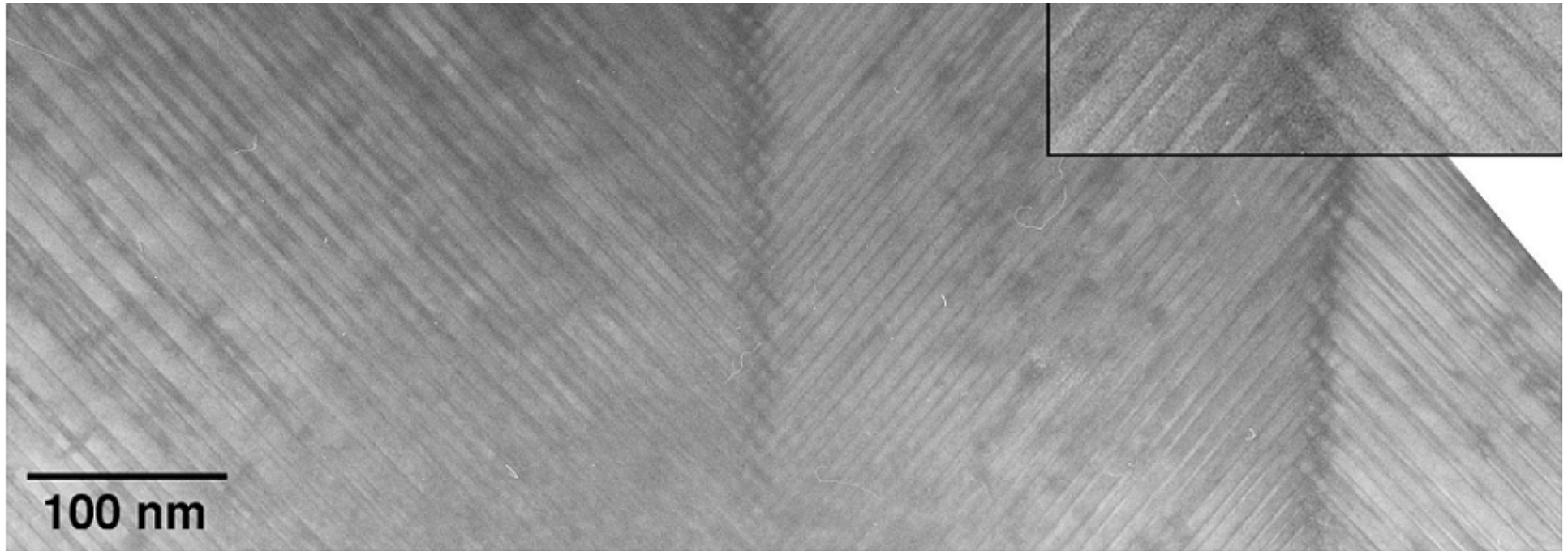

Martensitic microstructures in CuAlNi (Chu/James)

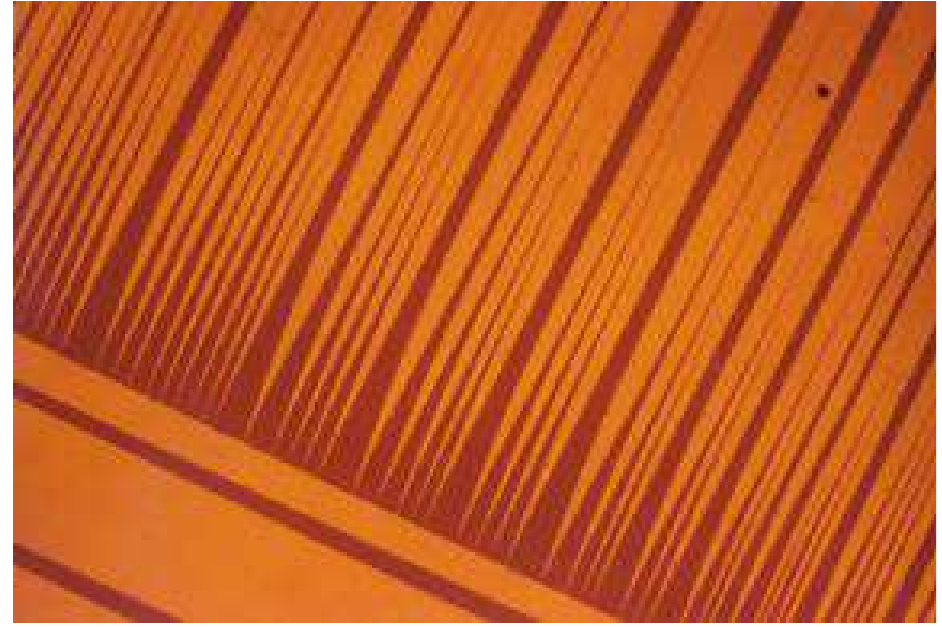
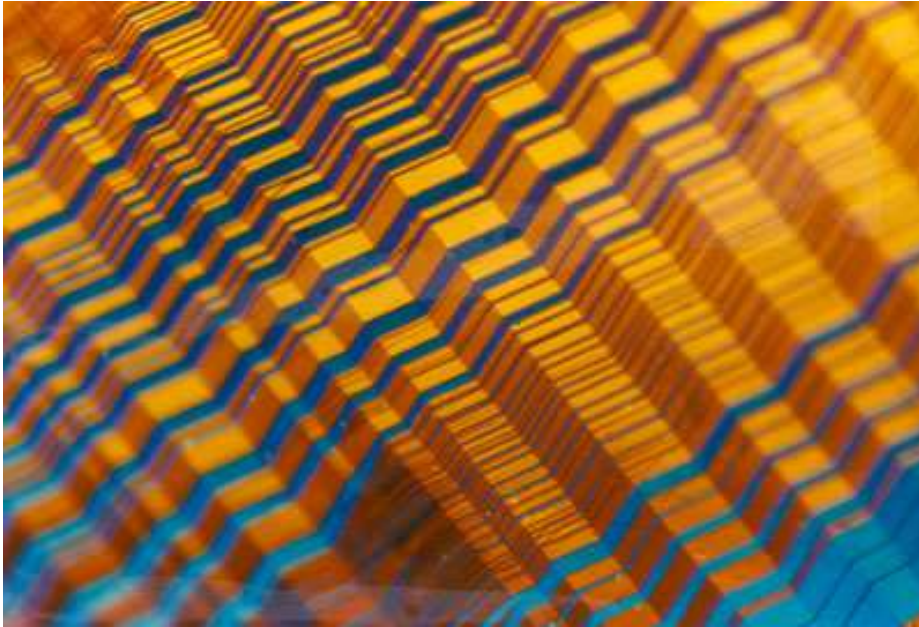

Interfaces correspond to pairs of matrices A, B with $A - B = a \otimes N$, where N is the interface normal. At minimum energy $A, B \in K(\theta)$.

There are no rank-one connections between matrices A, B in the *same* energy well. In general there is no rank-one connection between $A \in SO(3)$ and $B \in SO(3)U_i$.

Given $U = U^T > 0$ and $V = V^T > 0$, when is there a rank-one connection between $SO(3)U$ and $SO(3)V$?

That is, when are there rotations R_1, R_2 and vectors c, N such that

$$R_1U = R_2V + c \otimes N$$

Theorem 26

Let $D = U^2 - V^2$ have eigenvalues $\lambda_1 \leq \lambda_2 \leq \lambda_3$. Then $SO(3)U$ and $SO(3)V$ are rank-one connected iff $\lambda_2 = 0$. There are exactly two solutions up to rotation provided $\lambda_1 < \lambda_2 = 0 < \lambda_3$, and the corresponding N 's are orthogonal iff $\text{tr } U^2 = \text{tr } V^2$, i.e. $\lambda_1 = -\lambda_3$.

In the case of martensitic variants with $U = U_i$, $V = U_j$, $i \neq j$, we have $U = QVQ^T$ for some rotation Q and so the condition $\text{tr } U^2 = \text{tr } V^2$ is automatically satisfied. Rank-one connections correspond to **twins** and the corresponding twin normals are always orthogonal.

In this case there is a simpler criterion for the existence of rank-one connections due to Forclaz, namely that

$$\det(U - V) = 0$$

Gradient Young measures

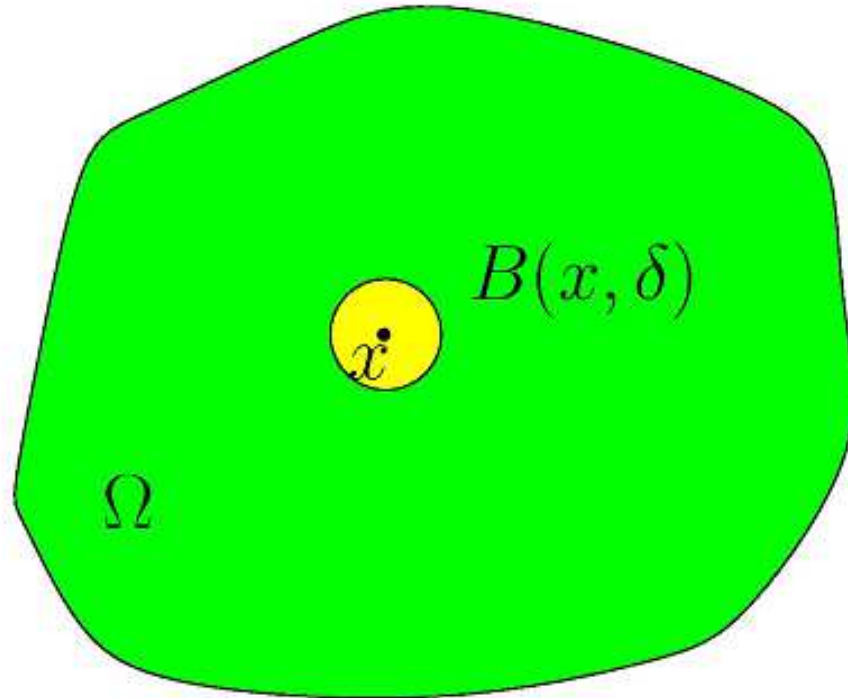

$$y^{(j)} : \Omega \rightarrow \mathbf{R}^m$$

Fix x, j, δ .

$$E \subset M^{m \times n}$$

$$\nu_x^{j, \delta}(E) = \frac{\text{Volume}\{z \in B(x, \delta) \text{ with } Dy^{(j)}(z) \in E\}}{\text{Volume } B(x, \delta)}$$

$$\nu_x = \lim_{\delta \rightarrow 0} \lim_{k \rightarrow \infty} \nu_x^{j_k, \delta}$$

Young measure corresponding to $Dy^{(j_k)}$.

The Young measure encodes the information on weak limits of all continuous functions of $Dy^{(j_k)}$. Thus

$$f(Dy^{(j_k)}) \xrightarrow{*} \langle \nu_x, f \rangle.$$

In particular $Dy^{(j_k)} \xrightarrow{*} \bar{\nu}_x = Dy(x)$.

Here

$$\bar{\nu}_x = \int_{M^{n \times n}} F \, d\nu_x(F)$$

and

$$\langle \nu_x, f \rangle = \int_{M^{n \times n}} f(F) \, d\nu_x(F)$$

Simple laminate

$$A - B = a \otimes N$$

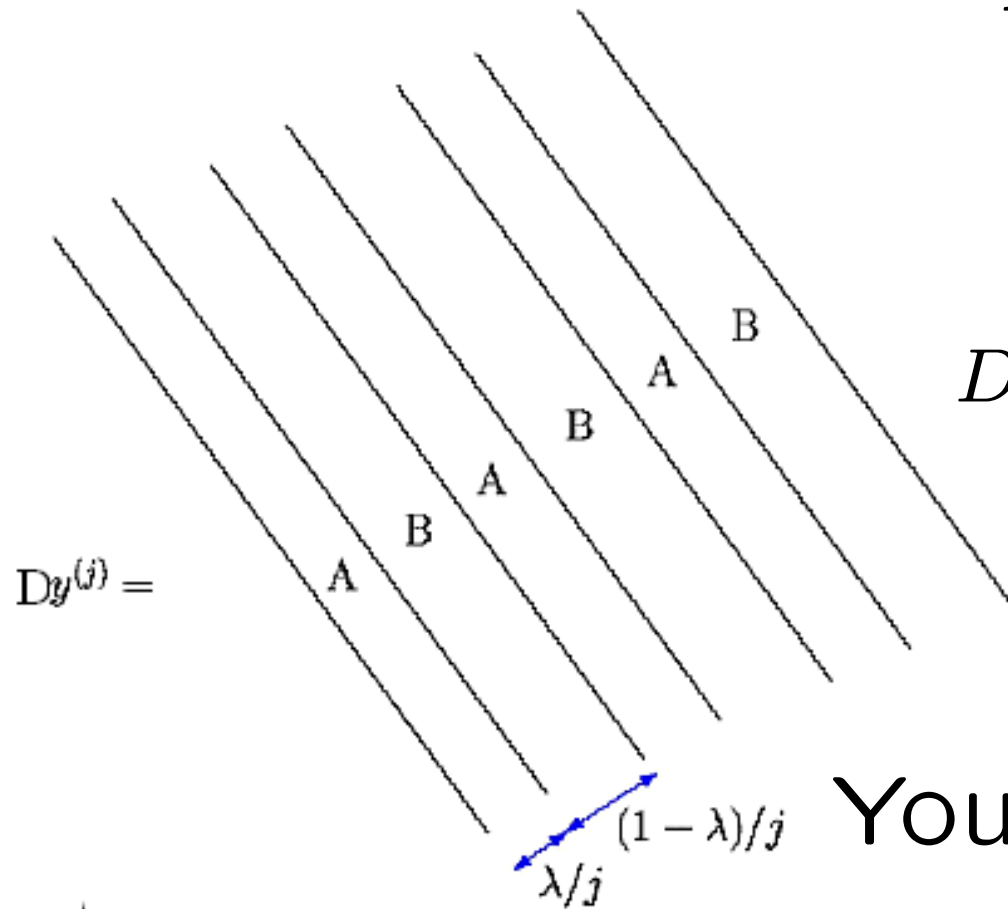

$$Dy^{(j)} \xrightarrow{*} \lambda A + (1 - \lambda)B$$

Young measure

$$\nu_x = \lambda \delta_A + (1 - \lambda) \delta_B$$

Theorem 27 (Kinderlehrer/Pedregal)

A family of probability measures $(\nu_x)_{x \in \Omega}$ is the Young measure of a sequence of gradients $Dy^{(j)}$ bounded in L^∞ if and only if

(i) $\bar{\nu}_x$ is a gradient (Dy , the weak* limit of $Dy^{(j)}$)

(ii) $\langle \nu_x, f \rangle \geq f(\bar{\nu}_x)$ for all quasiconvex f .

(Classical) austenite-martensite interface in CuAlNi
(C-H Chu and R.D. James)

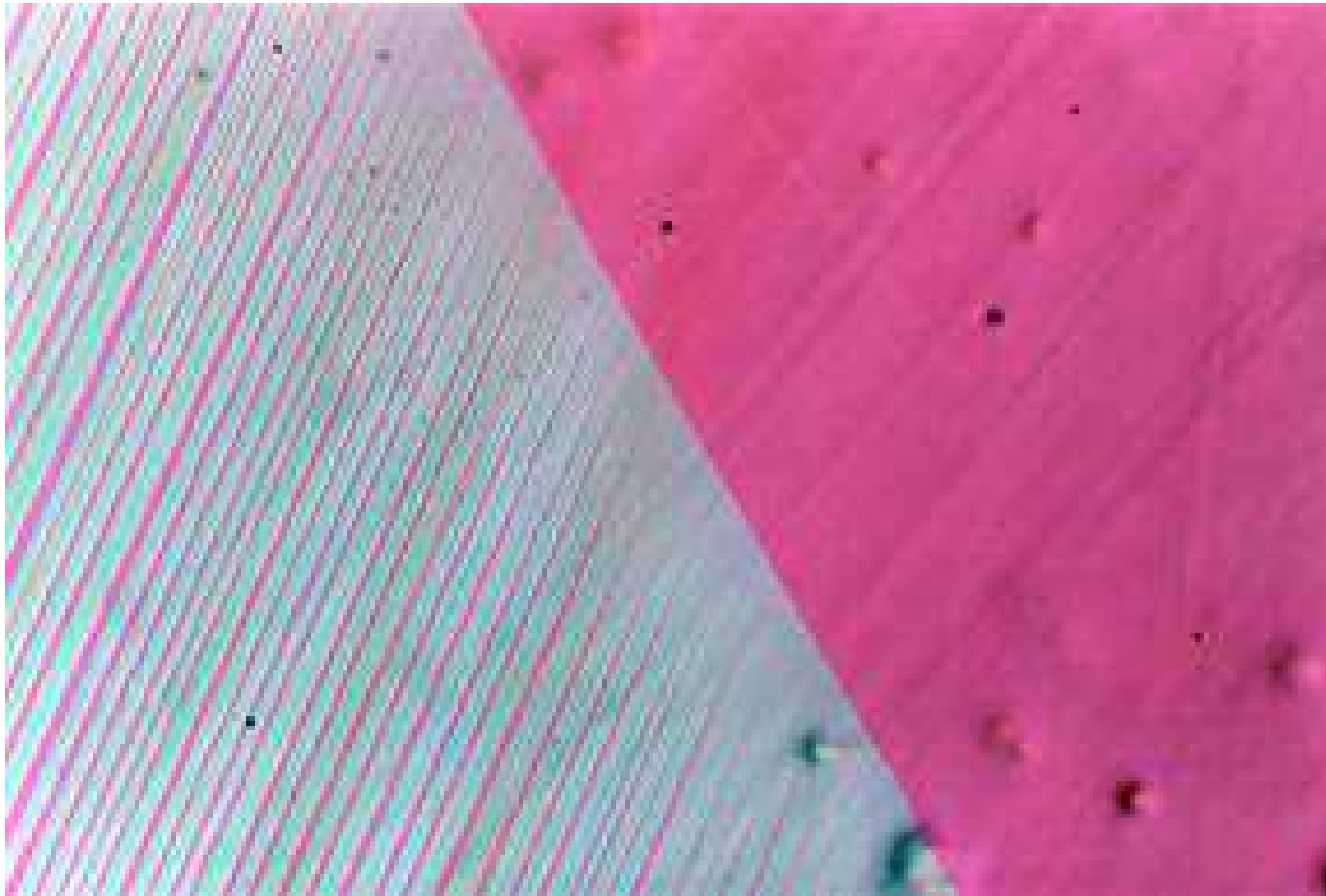

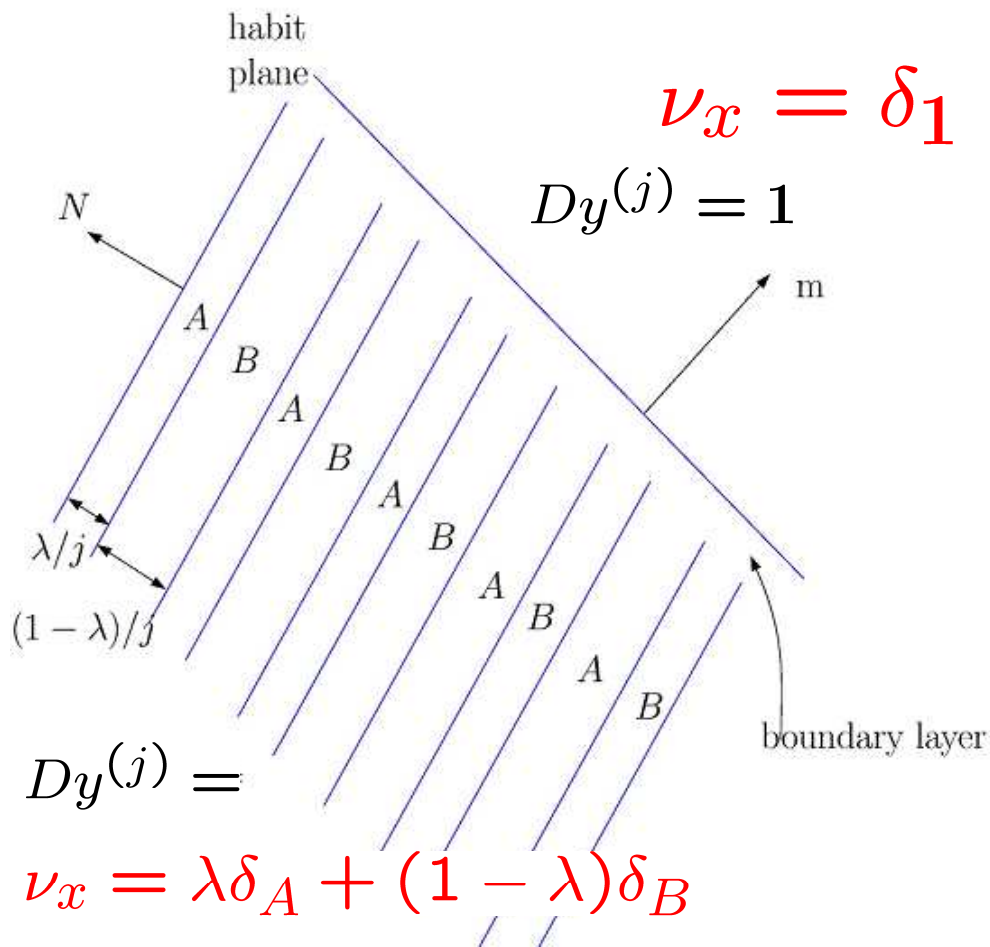

Gives formulae of the
 crystallographic
 theory of martensite
 (Wechsler, Lieberman,
 Read)

24 habit planes for cubic-
 to-tetragonal

Rank-one connections for A/M interface

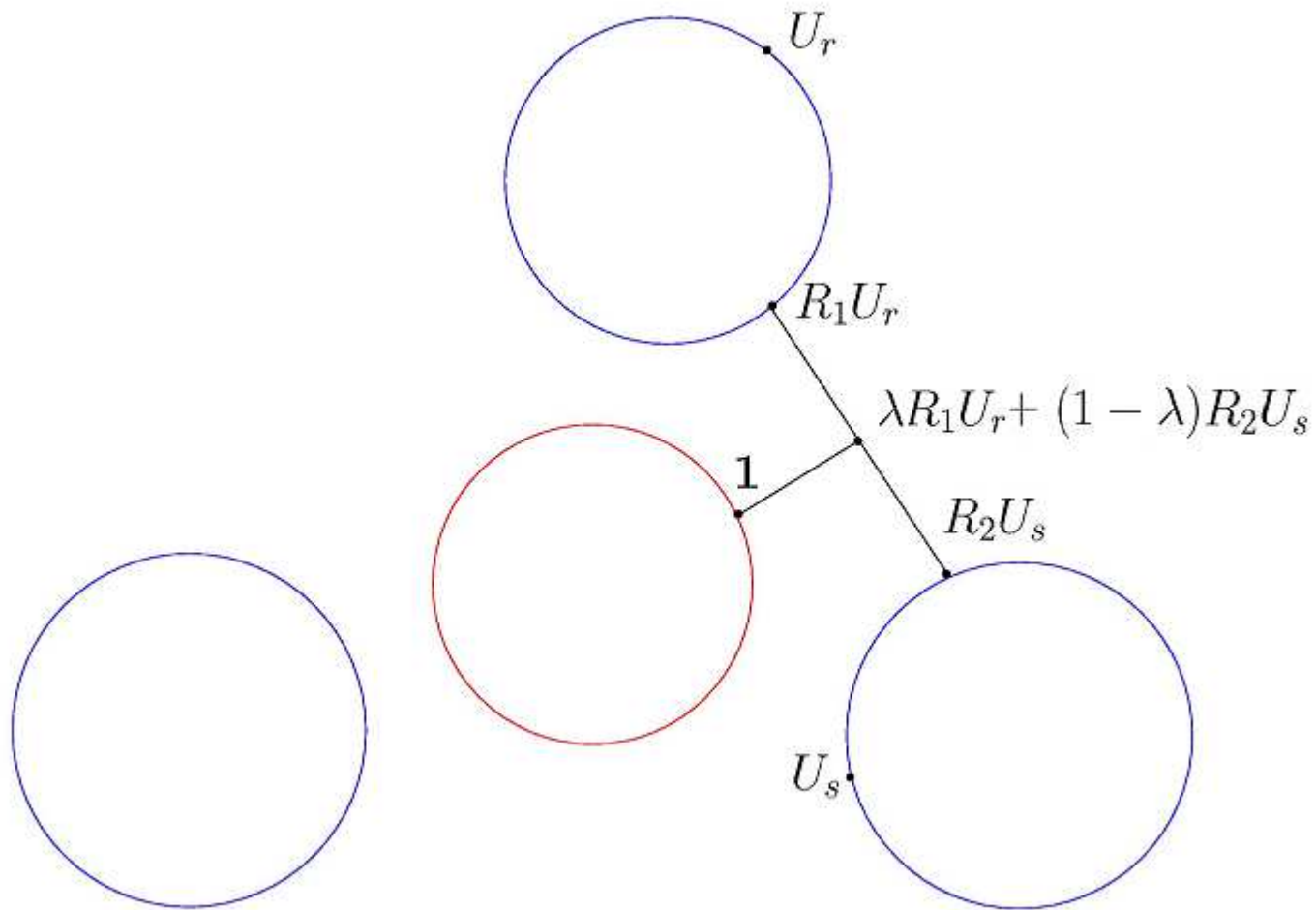

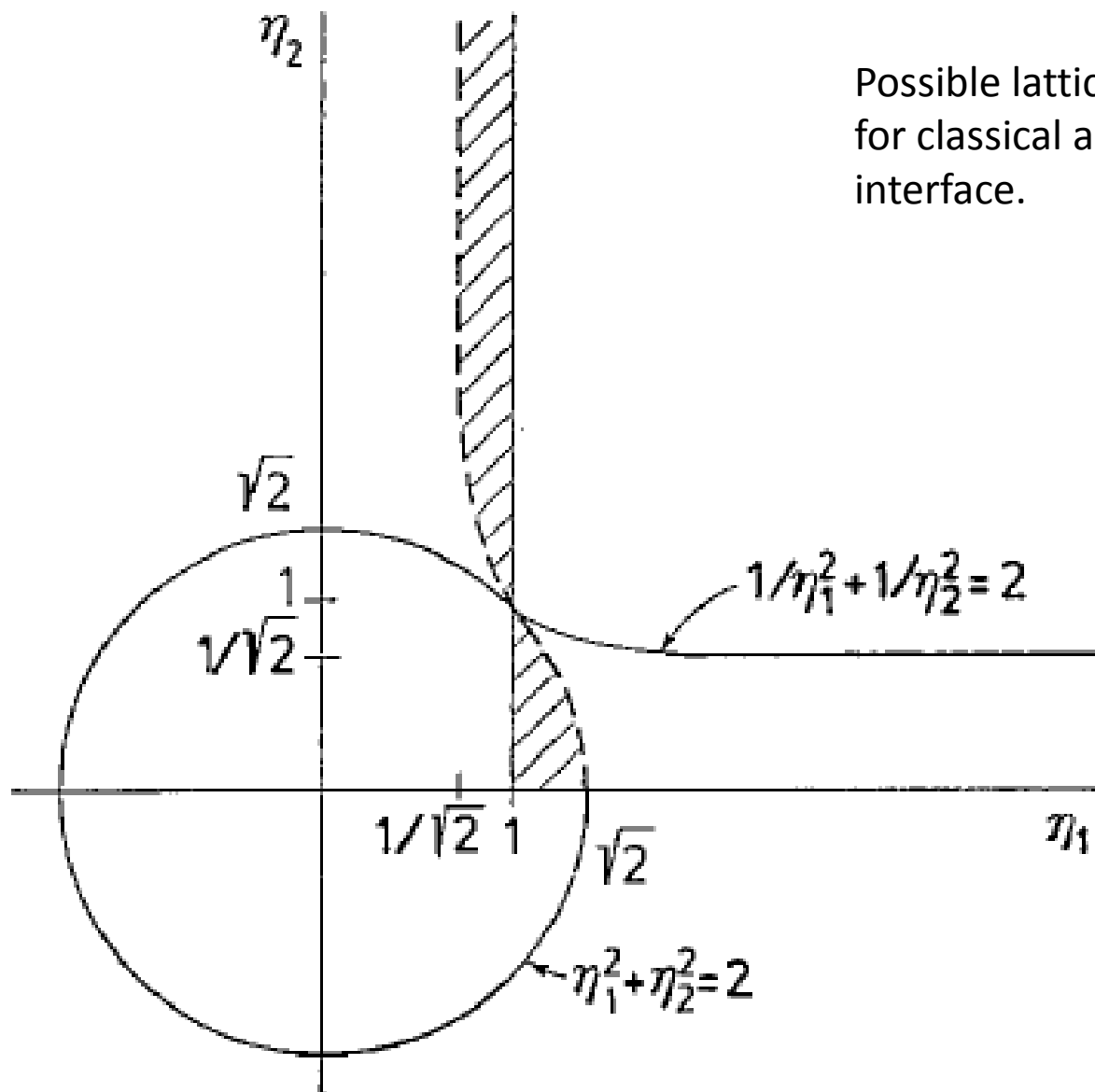

Possible lattice parameters
for classical austenite-martensite
interface.

Quasiconvexification

If $f : M^{m \times n} \rightarrow [0, \infty)$ then its **quasiconvexification** is defined to be the function

$$f^{\text{qc}} = \sup\{g \leq f : g \text{ quasiconvex}\}$$

.

$E \subset M^{m \times n}$ is **quasiconvex** if there exists a quasiconvex $f : M^{m \times n} \rightarrow [0, \infty)$ with $f^{-1}(0) = E$.

If $K \subset M^{m \times n}$ is compact, its **quasiconvexification** is the set

$$K^{\text{qc}} = \bigcap \{E \supset K : E \text{ quasiconvex}\}$$

$\psi^{\text{qc}}(F, \theta)$ is the **macroscopic** free-energy function corresponding to ψ .

$K(\theta)^{\text{qc}}$ is the set of macroscopic deformation gradients corresponding to zero-energy microstructures.

Nonattainment of minimum energy

Because of the rank-one connections between energy wells, ψ is not rank-one convex, hence not quasiconvex. Thus we expect that the minimum energy is not in general attained. We can prove this for the case of two martensitic energy wells.

Two-well problem

$$K(\theta) = SO(3)U_1 \cup SO(3)U_2$$

$$U_1 = \text{diag}(\eta_2, \eta_1, \eta_1), \quad U_2 = \text{diag}(\eta_1, \eta_2, \eta_1)$$

Theorem 28 (Ball\James)

$K(\theta)^{qc}$ consists of those $F \in M_+^{3 \times 3}$ such that

$$F^T F = \begin{pmatrix} a & c & 0 \\ c & b & 0 \\ 0 & 0 & \eta_1^2 \end{pmatrix},$$

where $ab - c^2 = \eta_1^2 \eta_2^2$, $a + b - |2c| \leq \eta_1^2 + \eta_2^2$.

If $Dy(x) \in K(\theta)^{qc}$ a.e. then y is a plane strain.²⁶⁸

Corollary 4 (Ball \ Carstensen)

Let $F \in K(\theta)^{qc}$ with $F \notin K(\theta)$. Then the minimum of $I_\theta(y)$ subject to $y|_{\partial\Omega} = Fx$ is not attained.

$K(\theta)^{qc}$ unknown for three or more wells.