

6.0

Architectural Strategy

6.1 The Concept

“Exeter College prizes above all else the importance of the Residential College as an intellectual meeting place for different disciplines and different levels of scholarship”

Exeter College’s aspiration to create an ‘intellectual meeting place’ reinvigorates the collegiate ideal to serve the Exonian community long into the next century. We understand that learning through social interaction, co-habitation and personal encounter in a variety of settings, is the unique academic opportunity offered by the Oxford College. The College Quad is the collegiate *home* for the meetings of minds and kindred spirits.

Exeter College will have a key role to play in its new Walton Street context, by:

- enabling a greater understanding of Ruskin College’s historic role for the local community
- providing access to new facilities for use by the community such as the lecture hall
- providing a fully accessible building and amenity spaces
- providing a low carbon, adaptable and sustainable building fabric for the long term

Our proposals aim to expand the possibilities for interaction, community engagement and familial connectivity amongst the new Quad’s inhabitants with an architecture that combines 21st C concepts of ‘gathering’, a respect for heritage, and an essential element of ‘home’ – the sheltering roof.

In our proposals for the Walton Street site, the traditional Quad arrangements of courtyard and cloister, façade and roof, have been reconfigured to intertwine and merge, loosening spatial relationships and blurring programmatic boundaries while offering a ‘coherent informality’ to a largely residential urban context. Every corridor, corner and ‘roofspace’ within the new Quad has been conceived as a place to dwell and opportunity to gather.

Derived from the Ruskin building’s pragmatic mansards, an expanded, over-arching roof form becomes the signifier of the College’s new presence in Oxford. The roof’s unique geometry and material becomes a unifying device between the old and new, a mediator between institutional and residential, and the all-embracing enclosure for a 21st century Exeter College at Walton Street.

6.1.1 Porters Lodge and Entry to the Building

Our proposal for the Entrance hall imagines a much more open configuration of the south side of the Entrance, setting off the massive presence of the masonry wall of the original Common Room opposite. A window seat will allow students and visitors to wait with a view to the Quad. A timber panelled wall sets the stage for passing into the Arcade and fully engaging in the new Collegiate setting.

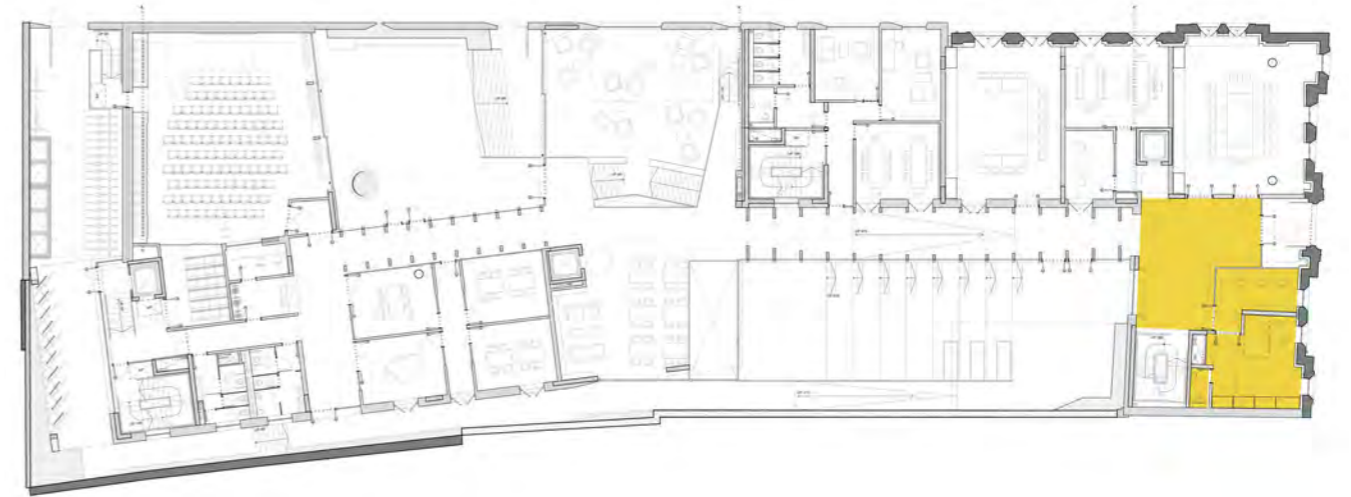

View of Porters Lodge

6.1.2
The S-Shaped Plan: An Ambulatory Connecting two Garden Quads

The new Quad has been conceived to provide a narrative experience of the site, with routes and spaces choreographed to encourage social exchange and chance encounters, an 'Ambulatory'. The ambulatory forms a continuous loop connecting the ground floor 'public' spaces, leading to all the seminar and teaching spaces, offices, music rooms and Hall. This narrative begins with entering the Quad: through the historic facade and grand arch of Ruskin College, into a renewed collegiate institution. The foyer space Porters Lodge connects the main vertical and horizontal circulation elements including a staircase, new lift and an enclosed timber cloister leading through the south Quad to teaching and social spaces. The cloisters converge at the heart of the site in the central, informal social space, the Learning Commons. The Ambulatory route is an organising device for the project, and the cloisters, sculptural reinterpretations of the historic, vaulted Cloister.

A primary role of the ambulatory is to physically and conceptually link the historic College entrance with an 'enticing destination' for Exeter's visitors and residents at the farthest reach of the site - the Lecture Hall and Garden. From the lecture Hall Foyer, the Ambulatory leads past music rooms out to a garden Wall Walk. This Walk uses the setback provided by the new building, away from the listed wall adjacent to Worcester College Gardens, to form a continuous promenade. The Wall Walk leads from the Lane to the South Quad, doubling as a balcony overlooking the South Quad's amphitheatre.

In addition to the West Quad that opens onto Worcester Place, within our overall site and massing strategy, we have proposed to set all new Exeter Quad construction and façades 1.4m away from the Worcester College Boundary wall. This enables us to locate our main piled foundations away from the boundary wall and tree routes; provide space for maintenance and cleaning; and create the 'ambulatory'.

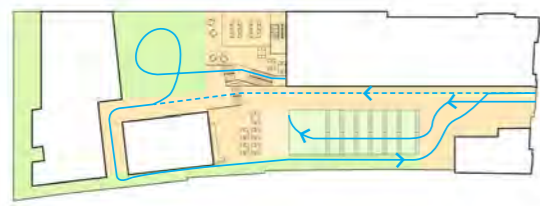

Ambulatory

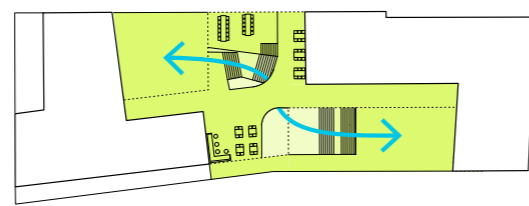

Continuous Landscape



Destinations along a route

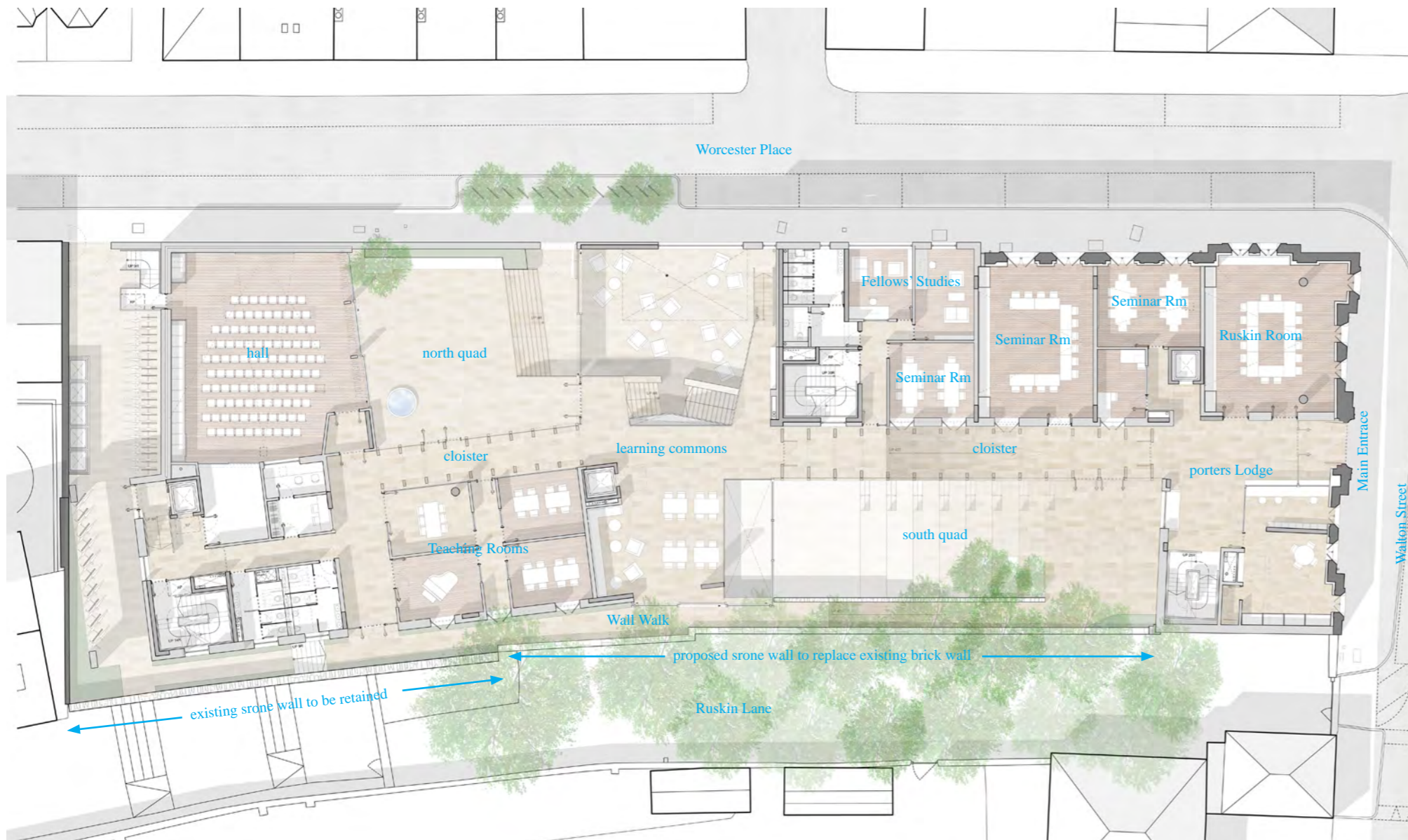

ground floor plan proposed

6.1 The Concept

6.1.3 Cloistered Quadrangles

New glazed South and North quad Cloisters maximise useable internal space on the site, and create an entirely new narrative experience of the collegiate Quad. ABA has derived the cloisters from an interest in the radiused arches of the Ruskin Building, and how this strongly identifiable form could be reinterpreted in a modern idiom.

The intention is that the South Quad cloister acts as a Room as well as a Passage. Therefore instead of straight sides and ceilings, the plan and sectional geometry of each cloister has been developed as a semi-elliptical space as if cut from a solid. This form was further translated into a series of timber fins set 1.4m apart. From the Porters Lodge the fins create a compelling forced perspective into the arcade. The fins act as a sun shading system, with niches between each fin for bench seating or work counters. The cloisters allow good

natural daylight into the seminar and offices facing the south Quad, and enable passive solar heating using the thermal mass of the stone floor and internal facade.

The cloister's elliptic geometries and steel reinforced structure are a result of contemporary 3D modelling tools which can easily generate complex geometries, analyze forces and enable streamlined production with computer aided manufacturing. We see the opportunity of the timber fins as potential places of embellishment, embossing and ornamentation, drawing on the iconography of Exeter's own ancient artefacts but generated with contemporary digital tools.



Location of north and south colonnades

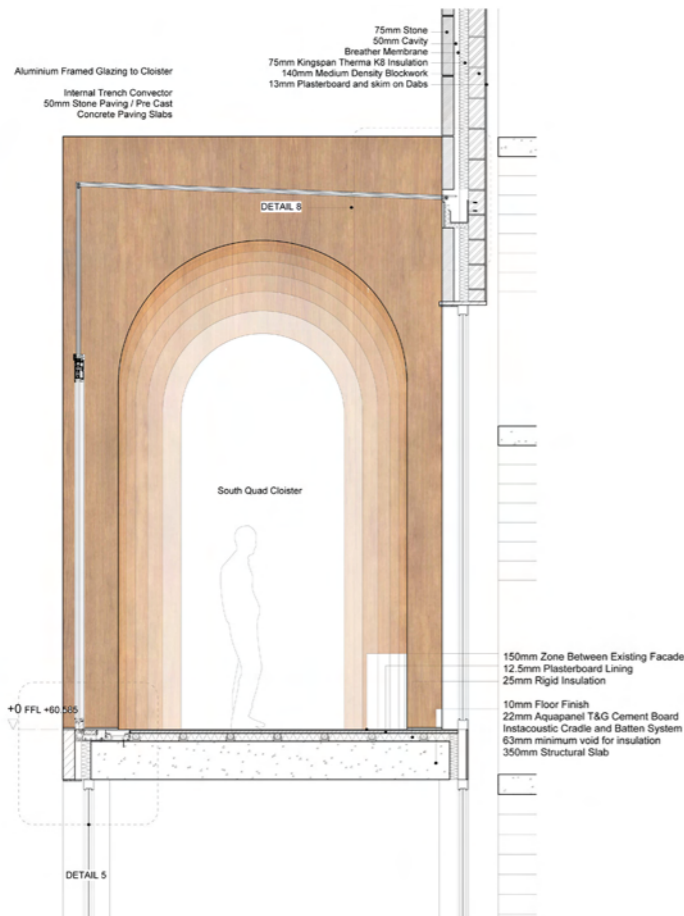

Section through cloister

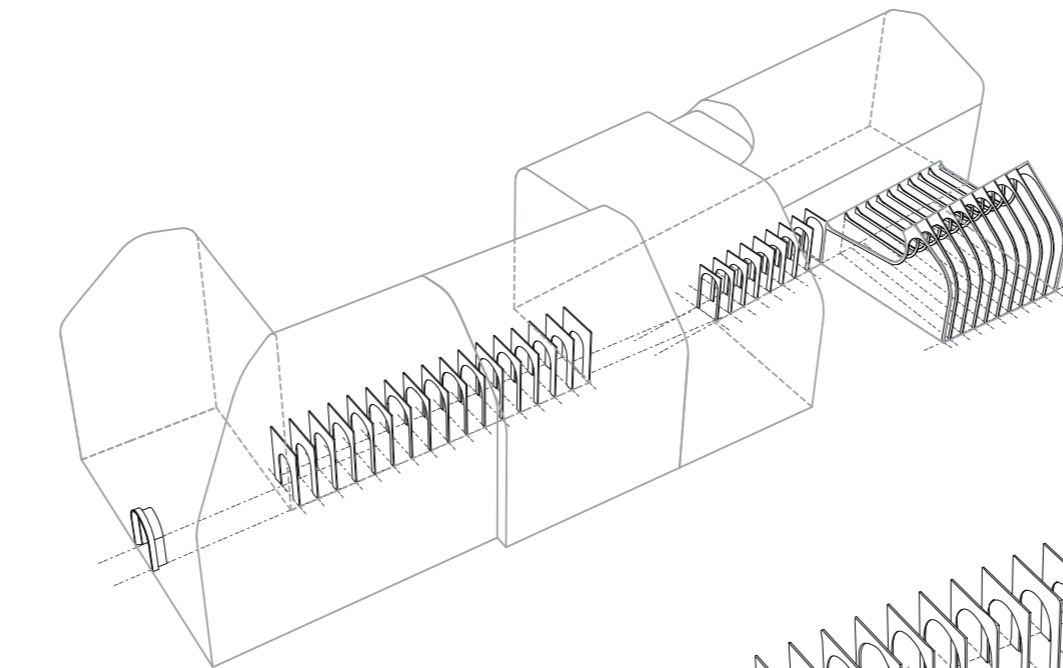

cloister axonometric

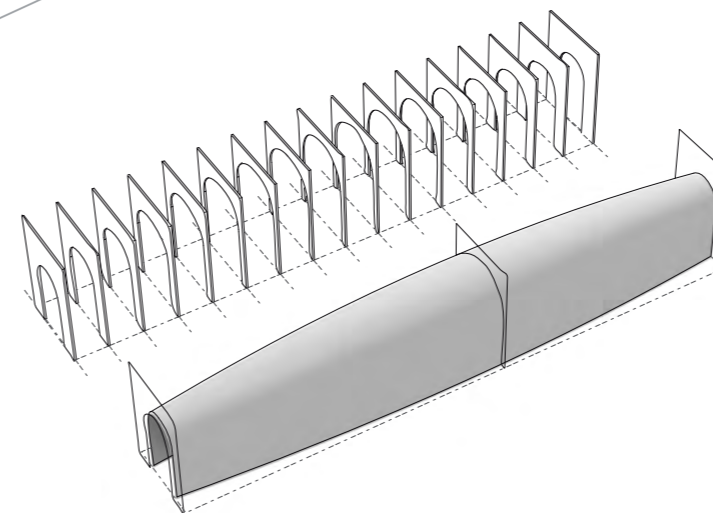

south quad cloister axonometric

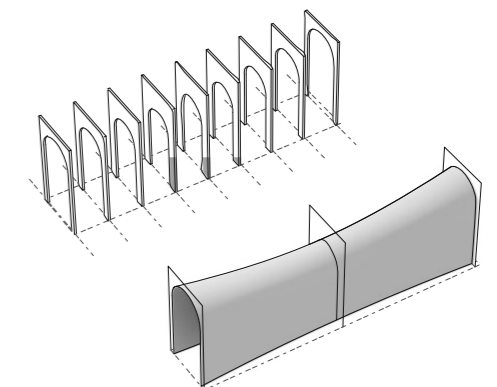

north quad colonnade axonometric



6.0 Architectural Strategy

6.1.4 The Heart of the new Quad: The Learning Commons

The proposed Ambulatory route connects various College teaching, social and public facilities along its length, and is centred on the Learning Commons. The Learning Commons is a space on four levels that forms the physical and social heart of the building, providing a setting for impromptu encounters. Large areas of glazing will maintain high levels of daylight and visual links to the quads beyond. It is envisaged that the learning commons will also be a location for artworks from the college's collection.

The Learning Commons offers a gradual vertical transition from the lower ground floor level to a mid-floor landing space, to the main floor level, and finally to a half level above, the 'Hanging Room'. The hanging room hovers over the mezzanine providing a space for informal meetings or private study.

The various levels of the Learning Commons are connected with a wide and inviting staircase with landings for seating and social study. At the lower level the café can open out onto the sunken garden in fine weather. Visually connecting every point within the two College Quads, the Learning Commons staircases, lifts and double height spaces generate a continuous 'landscape' in which students and Fellows can informally gather, meet and exchange.

At ground floor and lower ground level the Learning Commons is an open plan space where the careful choice of furniture and fittings will create places to chat, relax or read. It is important that any furniture is easily rearranged as the learning commons will also provide a spill-out area for the seminar rooms and Fellows' offices. Built in benching and laptop bars with IT servicing allow for informal drop-in laptop use and social study. While the intention is that this is a lively and busy space, noise disturbance will be carefully considered and acoustic measures will be incorporated to moderate any excessive reverberation.

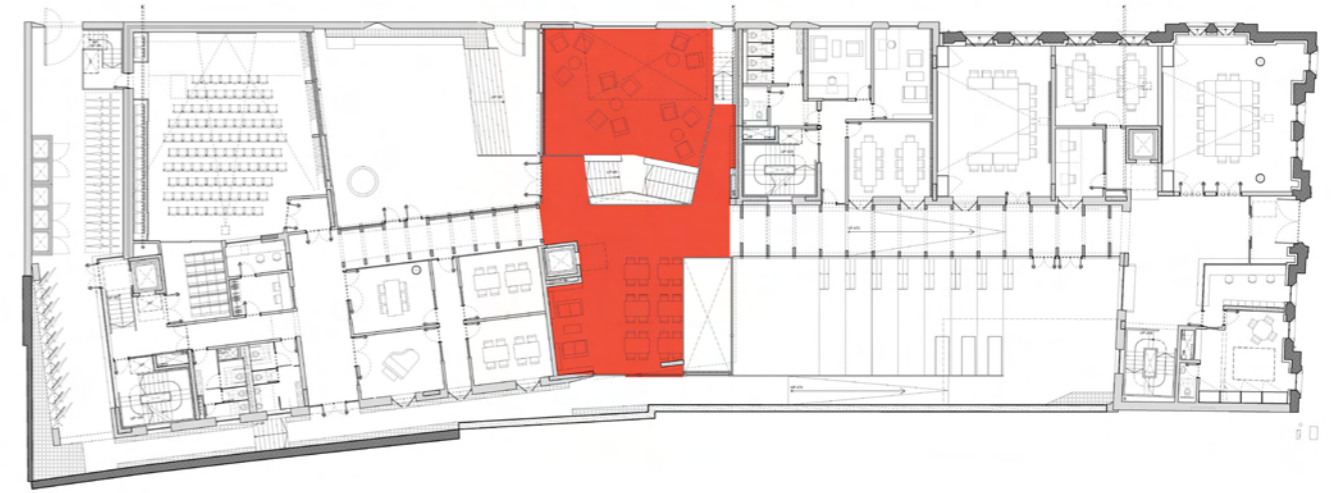

location of learning commons



short section through learning commons



Long section through learning commons



6.1 Architectural Strategy

6.1.5 Teaching and Seminar Spaces

The Accommodation requirements of the Brief have been organised to provide a clear separation between public/teaching and private/learning spaces. However visual and spatial connectivity between users of these spaces has been maximised wherever possible. Breaks in corridors permit natural light and views across exterior courtyards and green spaces, windows look across courtyards and toward other 'wings' of the building.

Of the two lifts provided in the scheme, a lift located at the west end of the Quad provides direct access to service areas for housekeeping staff.

The Accommodation has been generally arranged as follows:

- Lower Ground Floor
- Learning Commons Study areas
- Cafe
- Kitchen
- Junior Common Room

- Archive
- Service Laundry and Staff areas
- Plant Space

- Ground Floor
- Porter's Lodge and Public Areas
- Seminar Rooms
- The Ruskin Room
- Cloisters
- Learning Commons
- Multi-purpose Hall
- Music Practice Room
- Fellows' Study Rooms
- Offices

Second and Third Floor: Undergraduate Study Bedrooms, Communal 'Family' Kitchens
 Third Floor: Undergraduate Student Rooms, Fellows' Studies and Senior Common Room
 Fourth Floor: Fellows' Sets and Junior Dean's Set

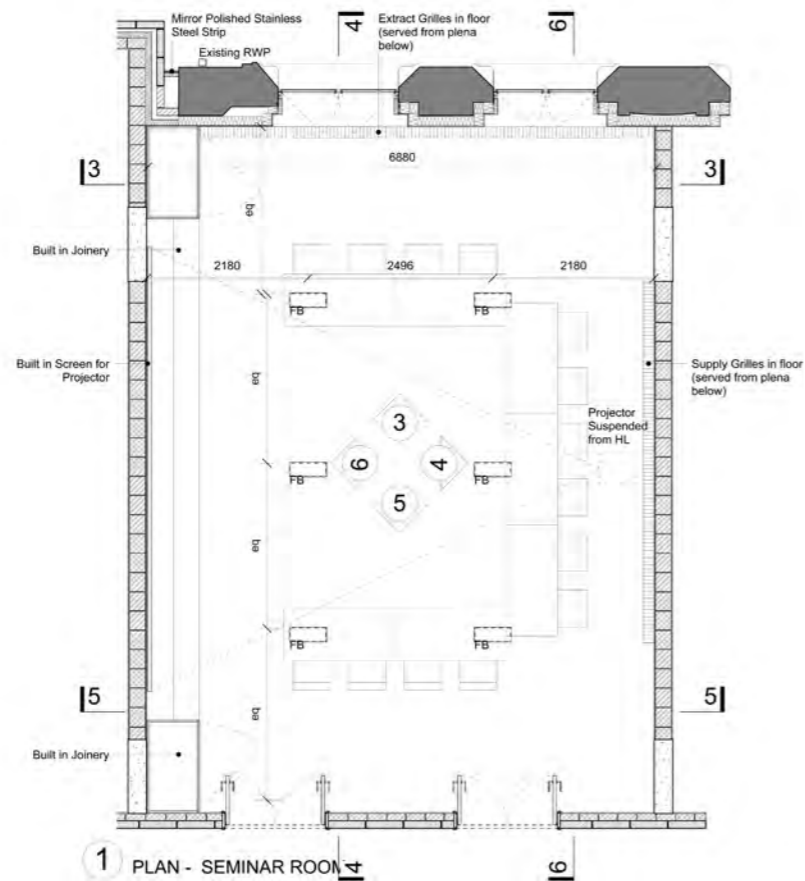

1 PLAN - SEMINAR ROOM



location of learning commons

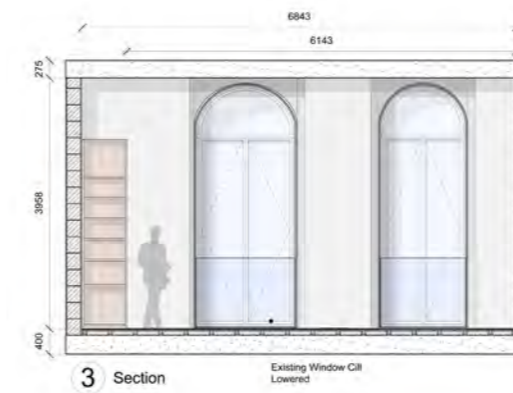

3 Section

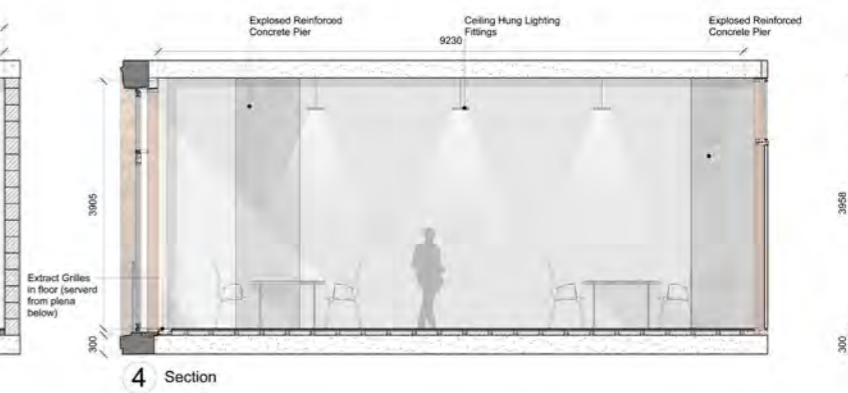

4 Section

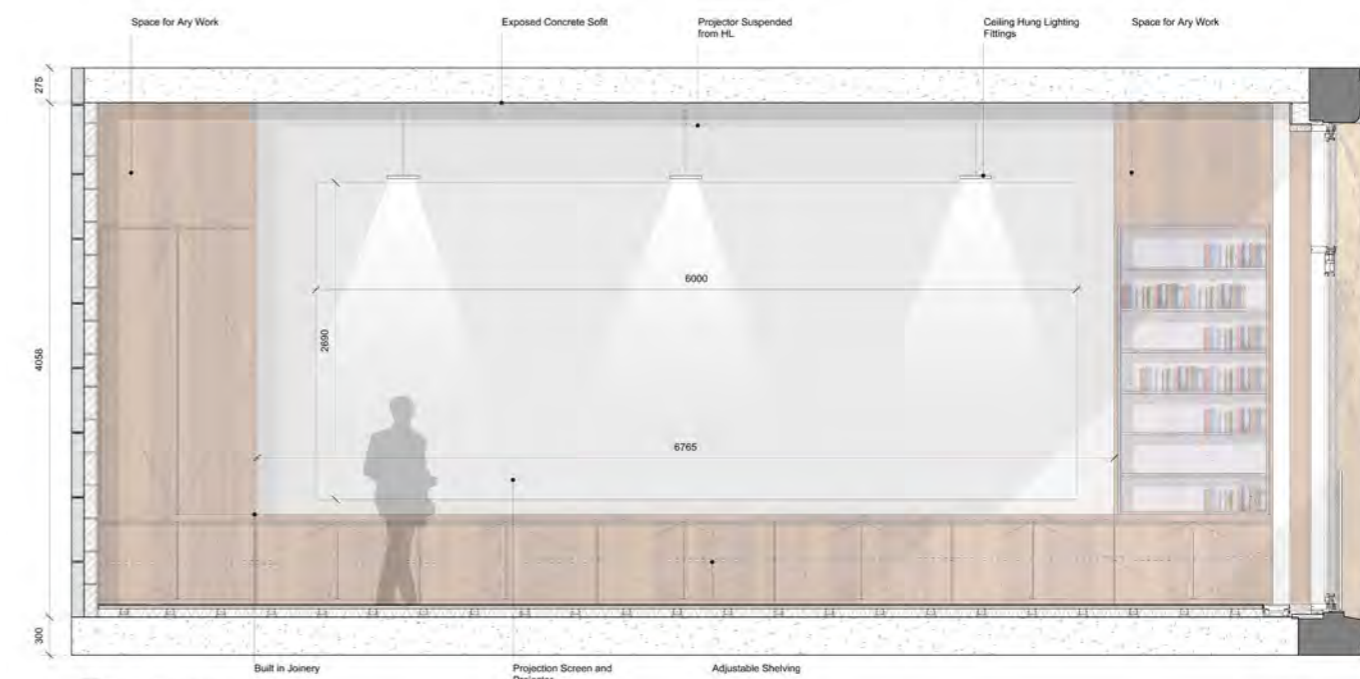

6 ELEVATION 1:25



Location of Multi Purpose Hall

6.1.6
The Lecture Hall

The North Quad is a walled courtyard space overlooked by the Learning Commons, North Cloister, and upper floor student rooms. It is also an open landscape setting for the Hall, accessible from Worcester Place.

The distinct form of the Lecture Hall has been conceived as both a jewel in the new Quad, and as a truly multi-functional event space with the option of access via the North Quad adjacent to Worcester Place. The Lecture hall is clad in the tiled roofing material of the Main Quad Roof, with an east façade that opens up onto the paved courtyard. In fine weather this direct and open relationship between Hall and the North Quad will offer opportunities for outdoor gatherings, ceremonies and events.

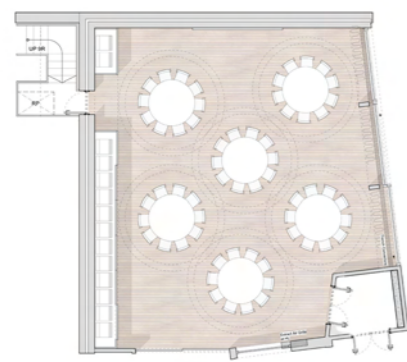

Round Dining Tables
Seating Capacity - 60

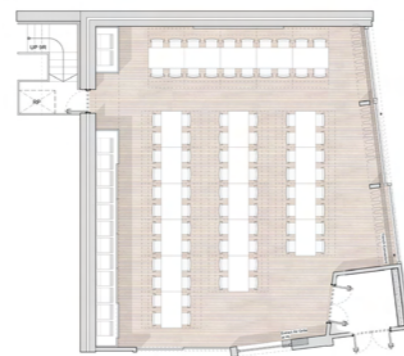

Rectangular Banqueting Table, with Top Table
Seating Capacity - 80

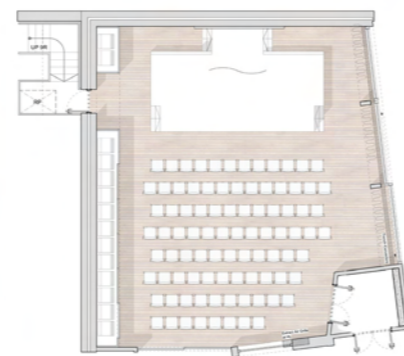

Theatre Production
Seating Capacity - 90

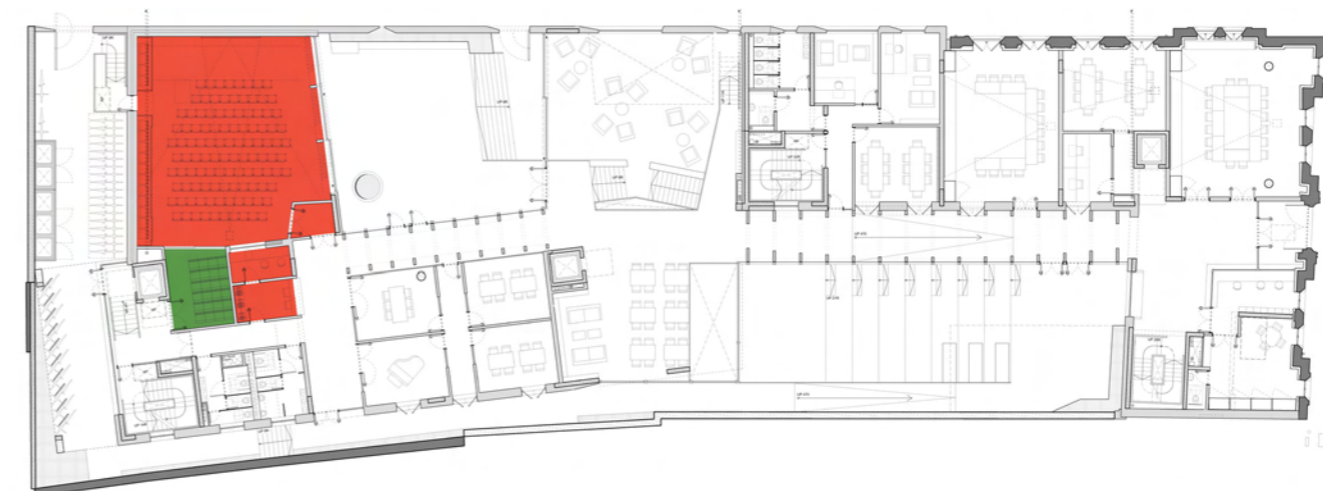

Location of LectureHall

6.1 Architectural Strategy

6.1.7 Student Floors

The design principles for the residential levels of the new Walton Street Quad has been guided by the desire for high-ceilinged, natural light filled corridors as opposed to the hotel-like passages that characterise most student residences in the UK today. By strategically locating two lift cores and four staircases within the maximum travel distances from room doors, we've been able to maintain the principle of natural light at the end of all new corridors.

Glazed dormers at the top of all the stairs will allow a moment of connection to the sky and the northern skyline of Oxford.

6.1.8 Family Kitchen on Every Floor

As per the Project Brief, large family kitchens are provided for 24 hour, occasional student use at the 1st, 2nd and 3rd floor levels. These kitchens will provide a place of 'domestic refuge' equipped with small scale cooking/heating facilities and built in furniture. The fourth floors will have a small galley kitchen for occasional use by the residential Fellows and Junior Dean. A small prep kitchen will serve the 3rd floor Fellows' Studies and Senior Common Room.

6.1.9 Student Rooms

ABA's proposal for the Walton Street Quad currently provides ninety Undergraduate Study Bedrooms. Our proposals for the Undergraduate study-bedrooms have been developed to achieve the following:

- Very generous desk space for spreading out books, a true 'worktable' as opposed to 'computer table'
- Desks oriented away windows to avoid the optical contrast between computer screen and background light
- Long shelves above desks to conceal desk lighting; create useful shelving without cluttering the room, framing a tack board below. The components of an intimate yet personalised working environment
- A window with generous height and vertical proportions to permit maximum benefit from daylight with integrated blinds for solar control
- Main windows set at 450mm above the floor to create a window seat
- A low level 'worktable window' that washes light obliquely across the desk surface
- A moveable under desk storage unit that can be used as a mobile work surface, side table or coffee table
- built-in hanging storage, shelving and drawers
- En suite bathroom pods potentially with clerestory glazing to allow natural light to reach the bathrooms.

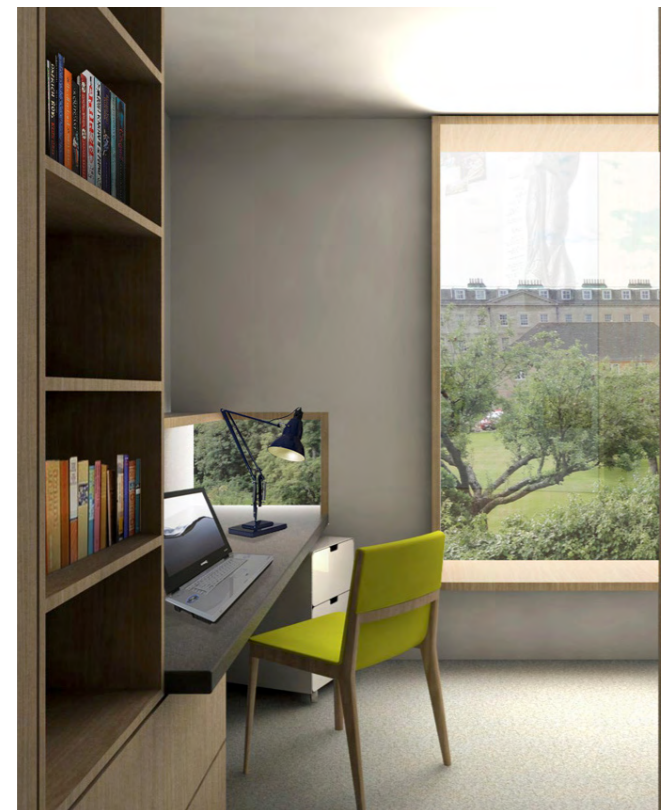

Interior View of Student Room

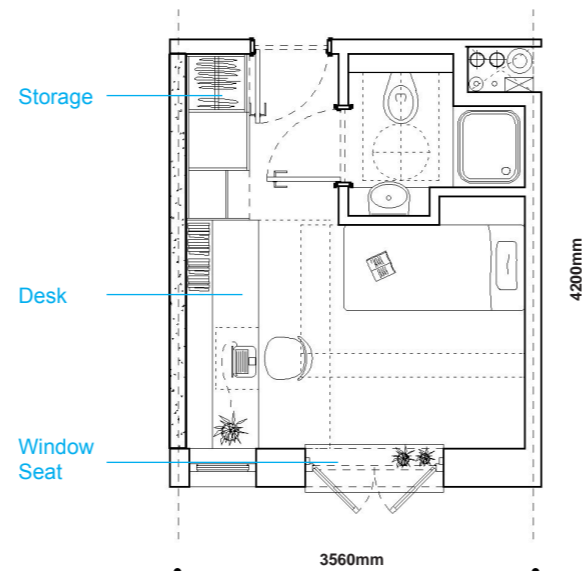

Undergraduate Bedroom - 15sqm



Interior View of Student Room

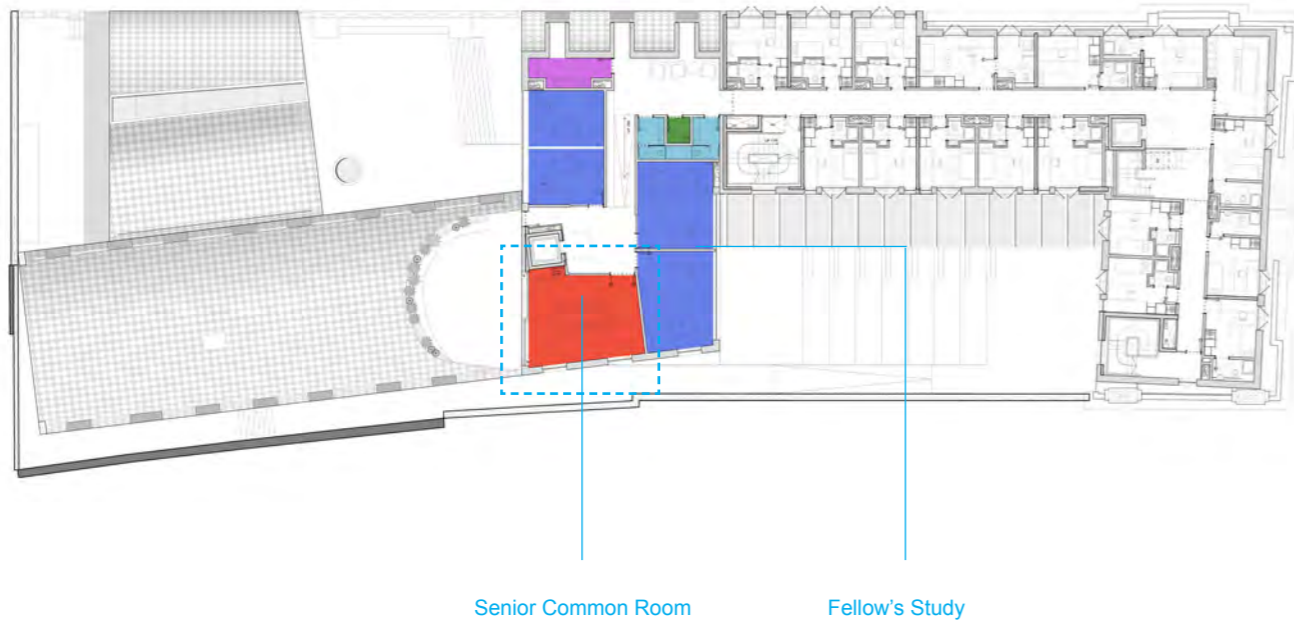

6.1.10
Fellows' Studies and SCR

The Fellows' Studies occupy two places in our proposed Exeter College plan. The main cohort of Studies has been located on the 3rd floor level, in the midpoint of the building's 'S' shaped plan, directly above the Learning Commons and easily accessible by lift. It is at this point where a transition takes place in the roof curvature, lowering from four storeys to three storeys. This step in building's geometry defines a 'house-like' element along the building's Worcester Street Elevation. Here 'under the roof' Fellows' Studies and a Senior Common Room are graced with lofty curved ceilings and expansive windows facing east and west.

A south-facing roof terrace is located alongside the Senior Common Room accessible from the main circulation. The terrace is set into the West wing, overlooking the North Quad. The Fellows' Terrace will be screened by the large evergreen Holm Oak trees of Worcester College. Balustrading formed by a sinuous cut in the curved roof profiles and curved glass.

A second location for Fellows' Studies is a set of rooms on the ground floor, accessed via the south Cloister or alternatively two rooms accessed from the West Cloister facing south. These rooms are flexible in allocation and will benefit from the option of closer engagement with the life of the street and the new more active and 'public' ground floor.

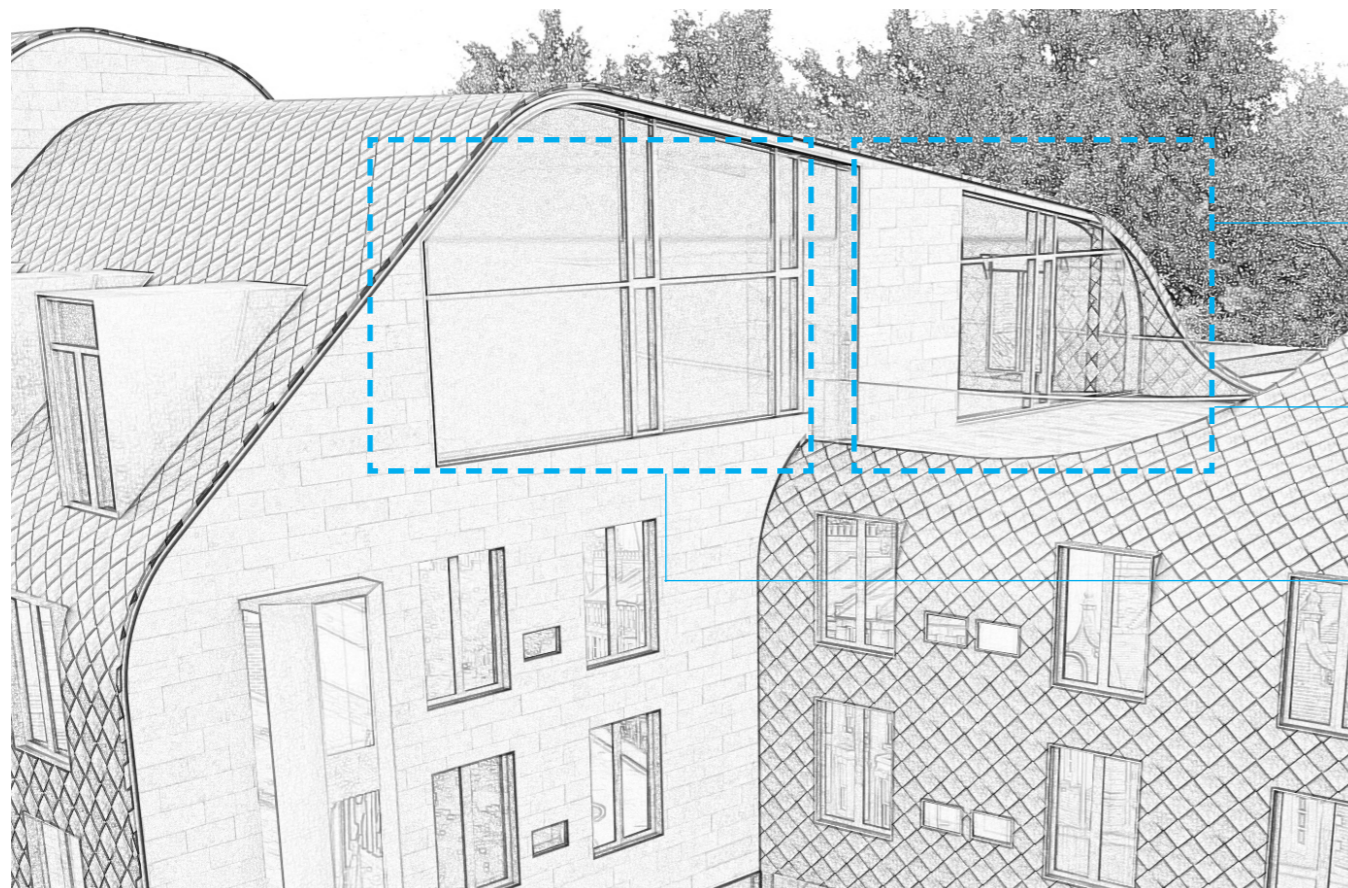

Exterior View of Fellows Study and Senior Common Room

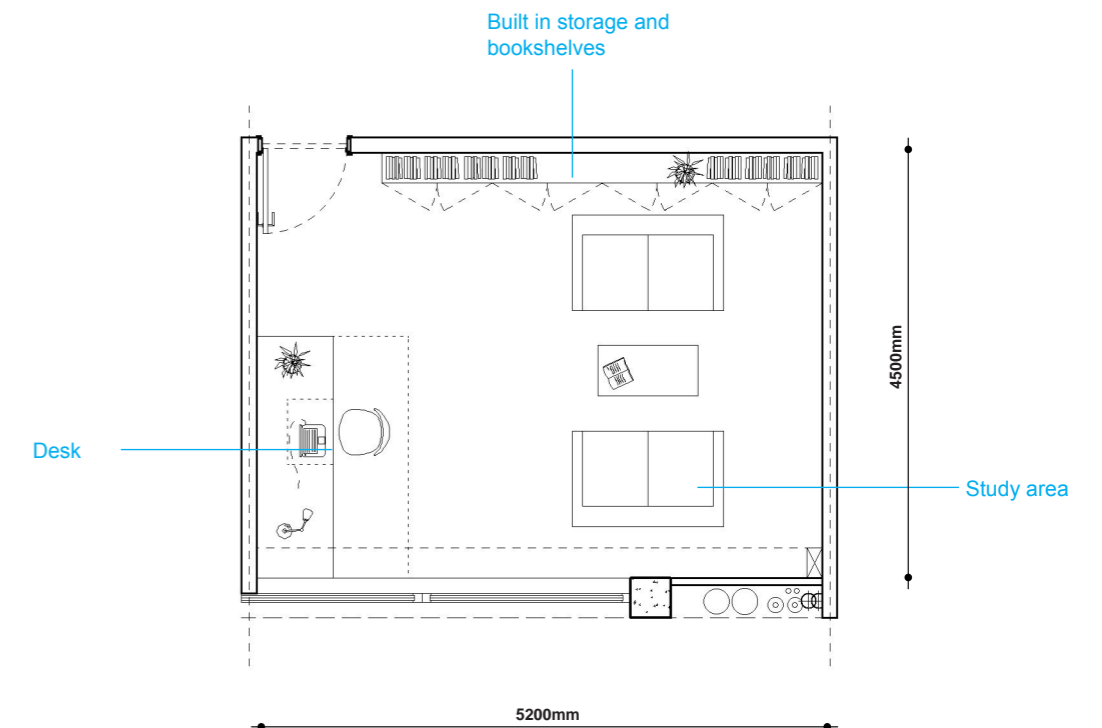

Plan of Fellows Study

6.5 Student Accommodation

6.1.11 Fellows' Sets

The extended roof of the proposals provide space for an additional 17 Undergraduate Study Bedrooms and 5 Fellows' Studies. These rooms can all have lofty ceiling spaces that follow the roof profile. Additionally the top floor Fellows' Sets have curved ceilings, punctuated by large dormer windows. These extraordinary study and teaching environments could be a major attraction to Fellows and Scholars to take up residence at the new Walton Street Quad.

The two Fellows' Sets and Junior Dean's Set are arranged on the highest floor of the Ruskin Building, within the new roof structure. Accessed by both Staircase and Lift, as self contained living and teaching spaces with double bedrooms and ensuite bathrooms.

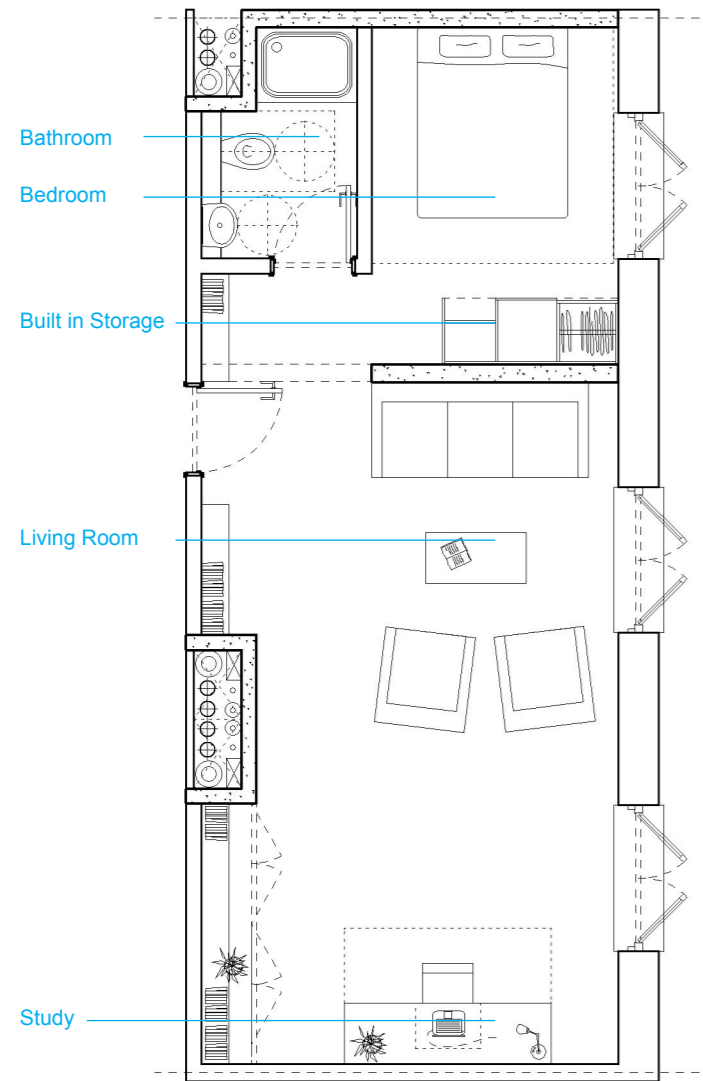

Plan of Fellows Set

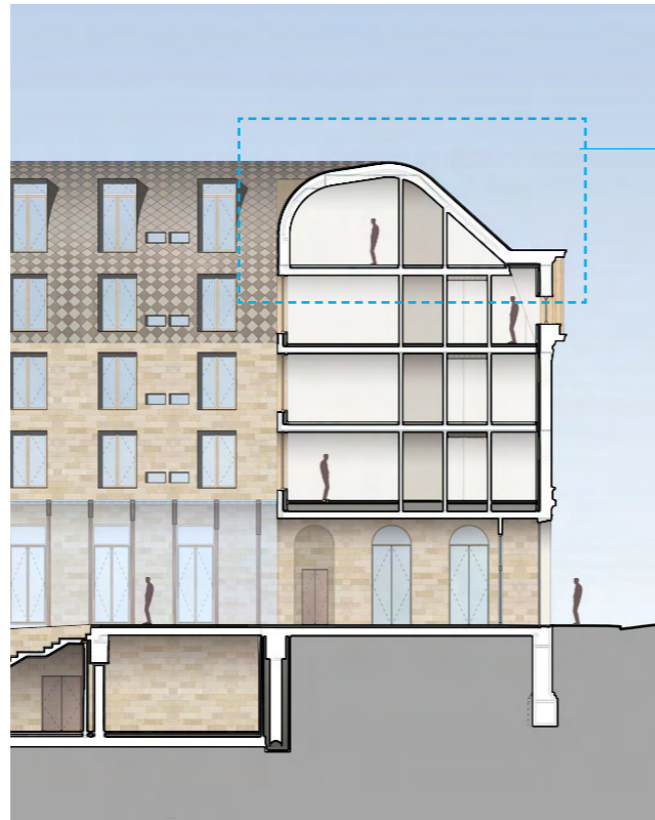

Section through Fellows Set

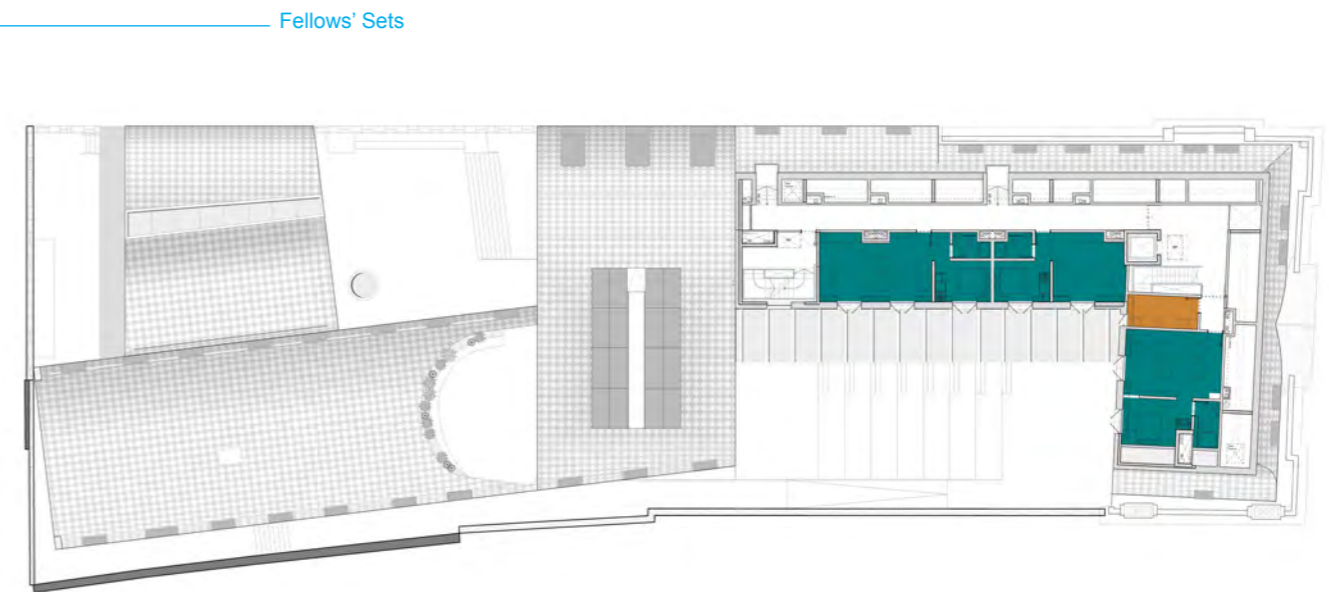

Fourth Floor Plan showing location of Fellows' Sets



Interior View of Fellows Set



Interior View of Fellows Set



6.1.12
Café

The café and servery is sited at the lower level of the Learning Commons, looking into the South Quad, where it is clearly visible from other ground floor spaces. The cafe can spill out into the south quad in good weather, and utilise the amphitheatre for additional seating. The cafe is intended to be both a focus for interaction between the users of the building and a facility that will act as a magnet to draw people into the building. It will also cater for visitors to conferences and seminars from outside the College. The choice of furniture in this location is key to allowing this space to be used in a variety of ways. Built in furniture along the south wall and a translucent closeable screen between the servery and dining tables will enable the cafe to double as a social study area when the kitchen is closed.

6.1.13
Service Spaces

The Porter's Lodge will provide a central point of security, information and communication with Exeter College's main campus at Turl Street. Publicly accessible washrooms are located at ground floor level, serving the east and west wings of the new quad. Visitors to the Hall will have direct access to washrooms from the Hall foyer.

The Quad's new basement level is located under the majority of the building footprint. This will house the lower Learning Commons, the Servery and Kitchen. A Junior Common Room off the Learning Commons can act as a games room for table tennis, snooker, and sports event viewing.

Back of house areas include a student laundry, IT server room, housekeeping storage and offices all serviced by stairs and a goods lift accessed from the service lane.

The basement will also accommodate a large area of mechanical and electrical plant space including a refurbished Scottish and Southern Electrical substation.

Lower Ground Floor Kitchen and Support Spaces

Location of Cafe in Lower Learning Commons



Section Through Lower Learning Commons



Exterior View of Lower Learning Commons

6.7 Lower Ground Floor

6.1.14 Archive

The purpose built archive will contain and preserve the College's collection of rare books and artifacts. It is located in the basement within a 4 hour fire protected "concrete box". The temperature and humidity levels within each archive space will be strictly controlled to the levels recommended in BS 5454 to provide appropriate environmental conditions. It will be equipped with roller archive racking to maximise the storage space and appropriate humidity and temperature control. The proposed solution for the main archive space is to use conventional library adjustable roller racking set within tracks recessed into the floor screed.

The proposed arrangement provides 1376 linear meters of usable shelf space.



Archive storage systems

6.1.15 Archive Reading Room

Adjacent to the main archive space, the archive Reading Room will hold an archive collection of material that will be accessed frequently by researchers. An on-site archivist will work from this space. A secure archive store room accessed from the main Archive room will hold the College's rarest archive material.

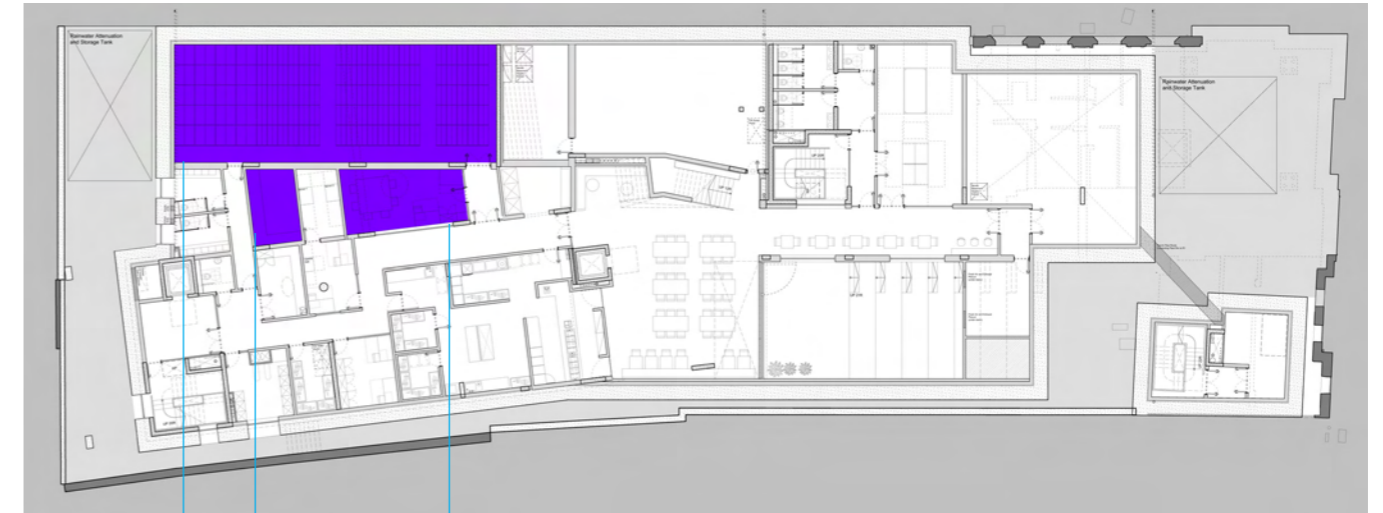

Archive Archive Secure Storage Archive Reading Room

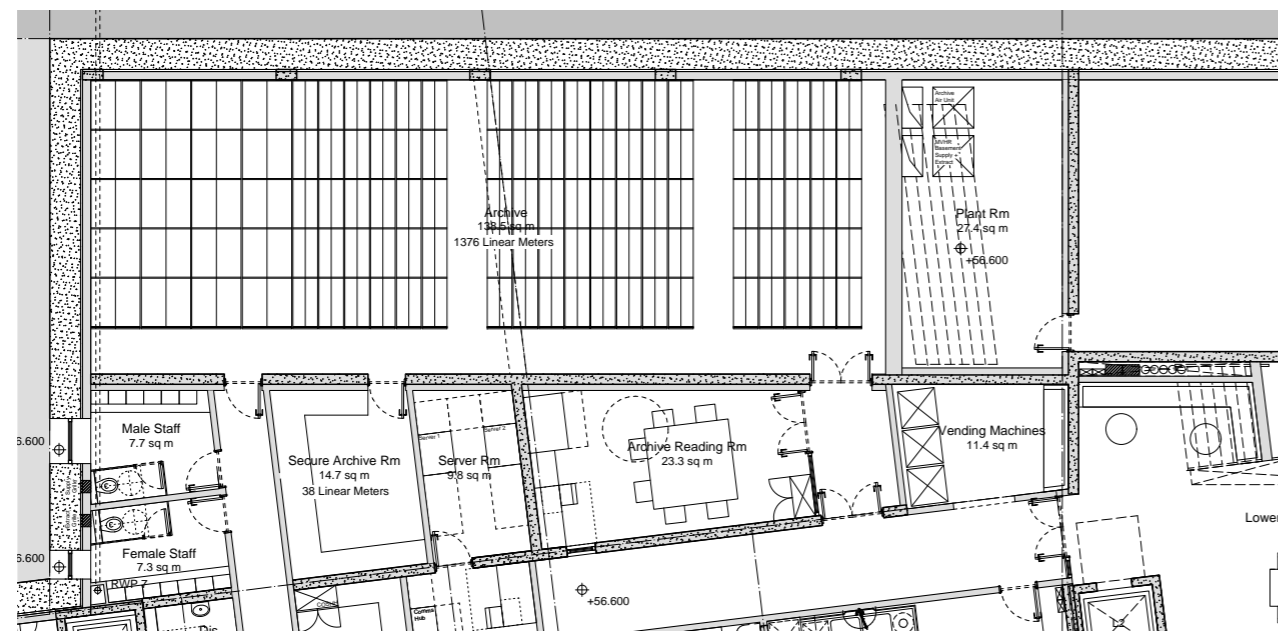

Plan of Archive

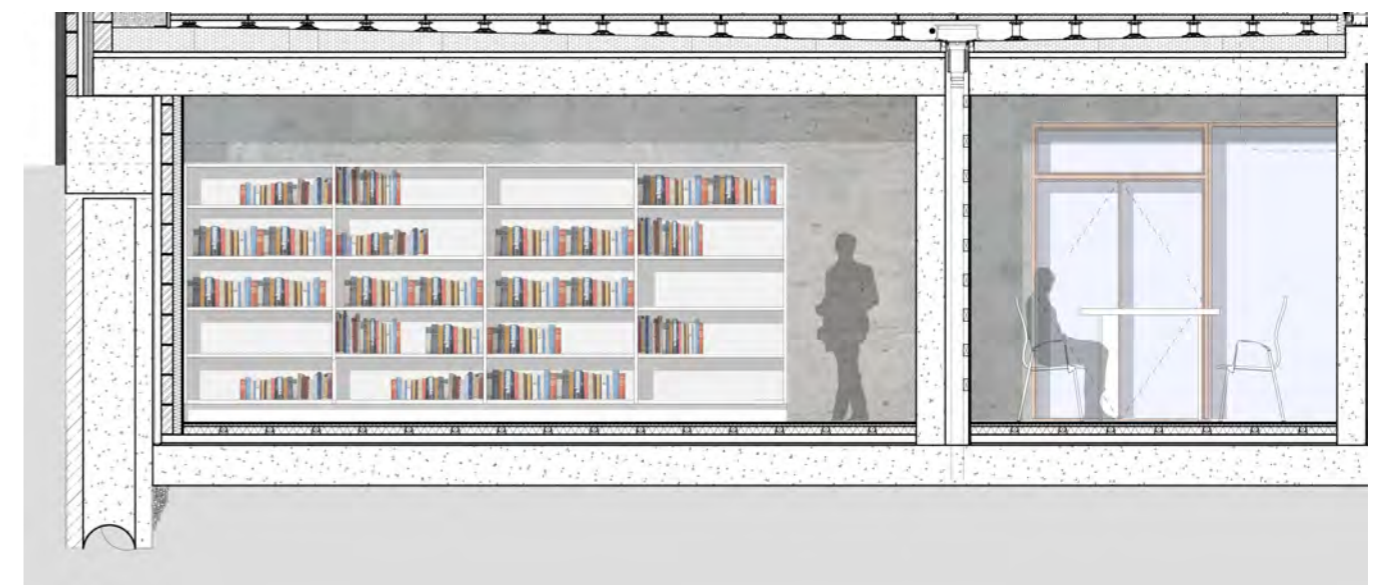

Section through archive